

# Billing



# Boats®

## WSP 10\*

### PHOTO MANUAL



## DK WSP 10

Skibet er bygget på Bodan-Werft GmbH Kressborn i 1989, længde 15m, bredde 3,90m. Den 30. juni 1989 blev WSP 10 afleveret til Wasserschutzpolizeidirektion Bayern, med hjemhavn i Passau ved Donau. Typebetegnelsen for denne type er områdebåd. 2 MAN dieselmotorer på hver 300 HK giver båden en hastighed på ca. 40 km/t. I normal tjeneste er båden bemanded med 2 mand, som råder over et moderne teknisk udstyr, såsom radar, ecolod, selvstyring, 4 radioanlæg og eksplosions sikring. Bådens og besættningens opgaver er meget bredt, såsom overvågning, specielt ved farligt gods, samt normale politiopgaver. En vigtig opgave er miljøopgaver. WSP 10 kontrollerer en strækning, som rækker fra den østrigske grænse og ca. 80 km opad strømmen.

## GB WSP 10

This ship, with a 15m length and a 3.9m beam, was built at the Bodan Shipyard in Kressborn, Germany, and delivered on 30th June 1989 to the Harbour Police in Bayern. The ship is stationed at Passau on the Danube. Of the regional boat type, the WSP 10 has 300 HP MAN diesel engines, which give an approximate speed of 40 kph. When on normal duty, the boat has a crew of two and various equipment, including radar, echo sounder, automatic pilot, 4 radios and an explosion safeguard. The boat and its crew have a wide variety of tasks, such as surveillance, especially in connection with dangerous cargoes, and normal police duties. Another important task is environmental surveillance.

The WSP 10 patrols an area stretching from the Austrian border and roughly 80 km upstream.

## D WSP 10

Gebaut wurde das 15m lange und 3,90 m breite Boot 1989 auf der Bodan-Werft GmbH in Kressborn am Bodensee. Am 30.6.1989 wurde 'WSP 10' für die Wasserschutzpolizeidirektion Bayern, mit Heimathafen Passau an der Donau in Dienst gestellt. Die Typenbezeichnung dieses Bootes wird als 'Streckenboot' bezeichnet. Zwei MANDieselmotore von je 300 PS verleihen dem Boot eine Geschwindigkeit von ca. 40 Kmh. Im normalen Dienst wird das Boot von 2 Mann gefahren, die über eine gut funktionierende Technik wachen, wie Radar, Echolot, Selbststeuer, 4 Funkgeräte sowie Explosionsschutz d.h. es kann ein Überdruck hergestellt und die frisch Luft über die Schornsteine angesaugt werden (bei Tankerunfällen). Die Aufgaben des Bootes und seiner Besatzungen sind sehr vielseitig und reichen von Überwachungen speziell bei Gefahrengut, Hilfeleistungen aller Art, normale Polizeiaufgaben, wie sie auch die PolizeiKollegen an Land inne haben. Ein wichtiger Faktor ist der Umweltschutz geworden, dem die Besatzungen große Aufmerksamkeit zukommen lassen. "WSP 10" kontrolliert eine Strecke die von der österreichisch/deutschen Grenze, bis ca. 80 km strom aufwärts reicht. An dieser Stelle möchten wir den bekannten Slogan verwenden der da heißt 'Dein Freund und Helfer' aber auf dem Wasser.

## F WSP 10

Ce bateau de 15m long et 3,9m de large a été construit au chantier naval Bodan de Kressborn en Allemagne et livré le 30 juin 1989 à la police portuaire de Bavière. Il est basé à Passau sur le Danube. A l'origine le WSP possède un moteur MAN Diesel de 300 chevaux, lui donnant une vitesse d'environ 40 km/h. L'équipage de 2 personnes a à sa disposition divers équipements dont un radar, une sonde acoustique, un pilote automatique, 4 radios et une protection anti-explosif. Le bateau et son équipage ont une grande variété de missions, telles que la surveillance, notamment des cargos transportant des matières dangereuses et des missions normales de police. Il s'occupe aussi de la protection de l'environnement. Le WSP 10 surveille une zone de 80 km jusqu'à la frontière autrichienne.

## NL WSP 10

Dit 15 meter lange en 3,90 meter brede schip werd gebouwd bij de Bodan Werf GmbH. In Kressborn, Duitsland. Op 30 juni 1989 werd het overgedragen aan de Waterpolitie van Beieren en met Passau aan de Donau als thuishaven in dienst gesteld. De twee MAN dieselmotoren van 300 pk. ieder geven het schip een snelheid van ongeveer 40 km/u. De normale bemanning bestaat uit 2 koppen, die gebruik kunnen maken van o.a. radar, echolood, automatische piloot en 4 radio's. Tevens is het schip explosie-beveiligd d.w.z. binnen het schip kan een overdruk opgebouwd worden, waarbij de verse lucht via de schoorstenen aangezogen wordt. De taken die boot en bemanning moeten uitvoeren bestaan uit o.a. normale surveillance, begeleiding van gevaarlijke transporten en milieu-controles. Het patrouille-gebied strekt zich uit van Passau aan de Duits-Oostenrijkse grens tot ca. 80 km. stroomopwaarts.

## E WSP 10

El barco fue construido en los astilleros de BodanWerft GmbH Kressborn en 1989. Eslora 15 m, ancho 3,90 m. El 30 de junio de 1989 WSP 10 fue entregado a la fuerza de policía 'Wasserschutzpolizeidirektion Bayern', domiciliada en Passau a orillas del Danubio. Este tipo de embarcación se denomina barco de zona. 2 motores diesel MAN de 300 CV cada uno aseguran una velocidad de unos 40 kilómetros por hora. Durante servicio normal la tripulación consta de 2 personas que disponen de un equipo técnico muy moderno, incluyendo radar, ecosonda, piloto automático, 4 equipos de radio y un dispositivo antiexplosivo. La tripulación del barco cumple una amplia gama de tareas, por ejemplo vigilancia, especialmente cuando se trata del transporte de mercancías peligrosas, y tareas de policía corrientes. Además, se dedican a tareas relacionadas con el medio ambiente. WSP 10 controla una zona que abarca desde la frontera de Austria hasta unos 80 kilómetros aguas arriba.

## I WSP 10

Questa nave, con una lunghezza di 15 metri e una larghezza di 3,9 metri, è stata costruita presso il cantiere navale Bodan di Kressborn, in Germania, e consegnata il 30 giugno 1989 alla Polizia Portuale della Baviera. La nave è di stanza a Passau sul Danubio. Si tratta di un tipo di imbarcazione regionale: il WSP 10 è dotato di motori diesel MAN da 300 HP, che garantiscono una velocità di circa 40 km/h. In servizio la barca ha un equipaggio di due persone e varie attrezzature, tra cui radar, ecoscandaglio, pilota automatico, 4 radio e sistema di protezione antideflagrante. La barca e il suo equipaggio devono svolgere molti compiti, come la sorveglianza, soprattutto in relazione a carichi pericolosi posti sopra altre imbarcazioni, e lavori quotidiani ad esempio controlli di polizia. Un altro compito importante è la sorveglianza ambientale. Il WSP 10 pattuglia un'area che si estende dal confine austriaco fino a circa 80 km a monte.

## P WSP 10

Este navio, com 15m de comprimento e 3,9m de boca, foi construído no Estaleiro Bodan em Kressborn, Alemanha, e entregue em 30 de junho de 1989 à Polícia Portuária da Baviera. O navio está estacionado em Passau, na Danúbio. Do tipo barco regional, o WSP 10 possui motores diesel MAN de 300 HP, que proporcionam velocidade aproximada de 40 km/h. Quando em serviço normal, o barco conta com uma tripulação de duas pessoas e diversos equipamentos, incluindo radar, ecobatímetro, piloto automático, 4 rádios e proteção contra explosão. O barco e a sua tripulação têm uma grande variedade de tarefas, tais como vigilância, especialmente em relação a cargas perigosas, e polícia normal obrigações. Outra tarefa importante é a vigilância ambiental. O WSP 10 patrulha uma área que se estende desde a fronteira austríaca e cerca de 80 km rio acima.

## PL WSP 10

Łódź o długości 15 m i szerokości 3,9 m, został zbudowany w Stoczni Bodan w Kressborn w Niemczech i przekazany 30 czerwca 1989 roku Policji Portowej w Bawarii. Statek stacjonuje w Pasawie nad Dunajem. Spośród łodzi regionalnych, WSP 10 jest wyposażony w silniki wysokoprężne MAN o mocy 300 KM, które zapewniają prędkość w przybliżeniu 40 km/h. Podczas normalnych obowiązków łódź ma dwuosobową załogę i różnorodne wyposażenie, w tym radar, echosondę, automatycznego pilota, 4 radia i zabezpieczenie przeciwwybuchowe. Łódź i jej załoga mają różnorodne zadania, takie jak obserwacja, szczególnie w związku z niebezpiecznymi ładunkami, oraz normalne obowiązki policyjne. Kolejnym ważnym zadaniem jest nadzór nad środowiskiem. WSP 10 patroluje obszar rozciągający się od granicy austriackiej i około 80 km w górę rzeki.

**To see our color conversion chart please visit <https://www.billingboats.com/faq>**

Til denne model er mahogni bejdse og farver med følgende numre nødvendige:

For this model is mahogany stain and colours with the following numbers should be used:

Für dieses Modell sind Mahagoni Beize und Farben mit den folgenden Nummern notwendig:

Pour ce modèle, le mordant et les couleurs avec les numéros suivants doivent être employées:

Voor dit model zijn kleuren met de volgende nummers nodig:

Para est modelo se necesitan mordiente et colores con los siguientes números:

Per questo modello occorrono inchiostro tinteggiatore "mogano" e colori con questi numeri:

Pinte o modelo com tintura cor Mogno e as cores sugeridas da Billing Boats:

W przypadku tego modelu należy użyć bejcy mahoniowej oraz farby o numerach:

Billing 1	= White
Billing 4	= Orange
Billing 6	= Hull Red
Billing 8	= Brunswick Green
Billing 11	= Black
Billing 15	= Silver
Billing 16	= Gold
Billing 18	= Mediterranean Blue
Billing 35	= Signal Red

	Part number (* alternative part)		Cut out		Use putty (fill and sand)
	Paint number (* alternative colour)		Drill a hole		Part made with layers
	Give shape (for example use sand paper)		Fit to other parts		Paint with primer paint
	Use cyanoacrylate glue				

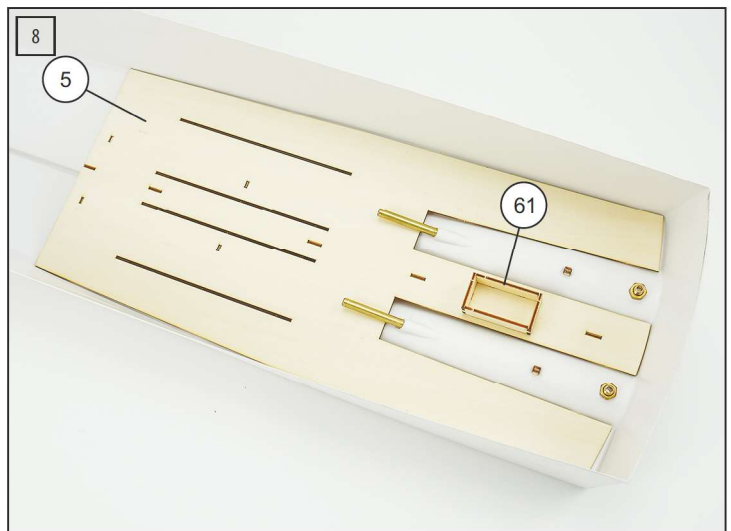
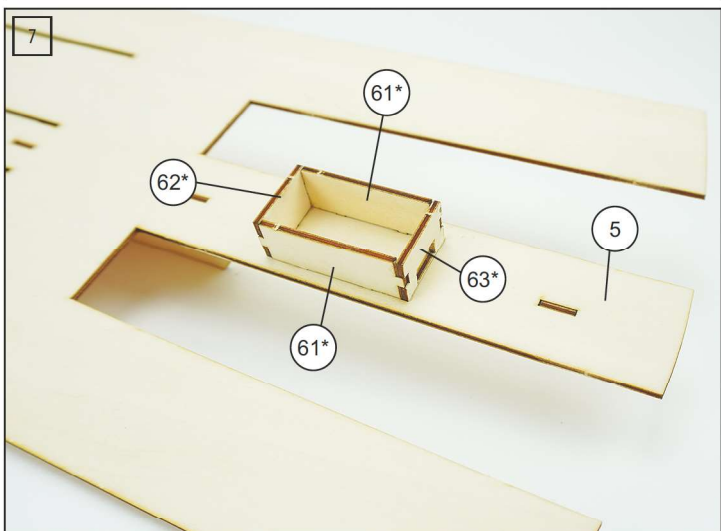
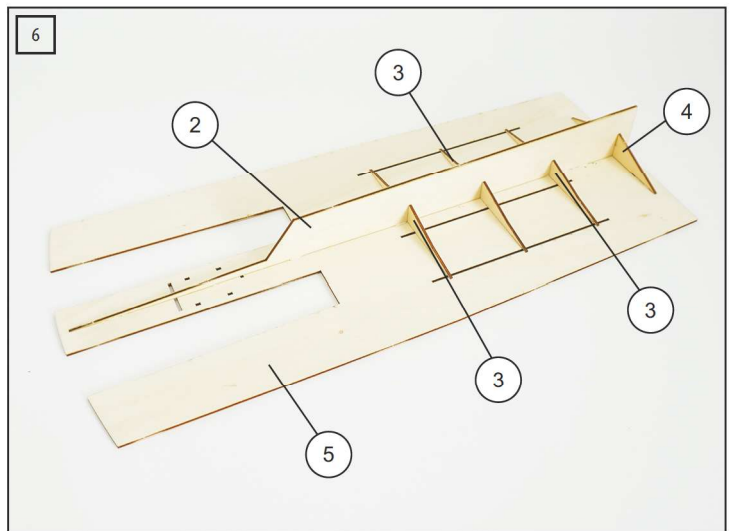
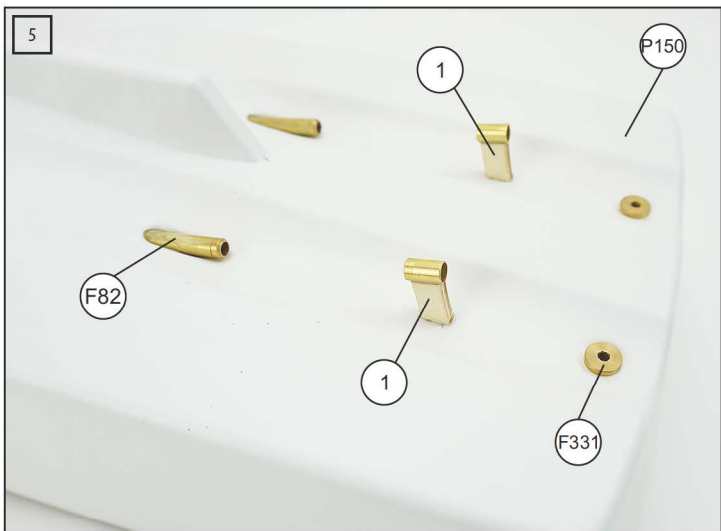
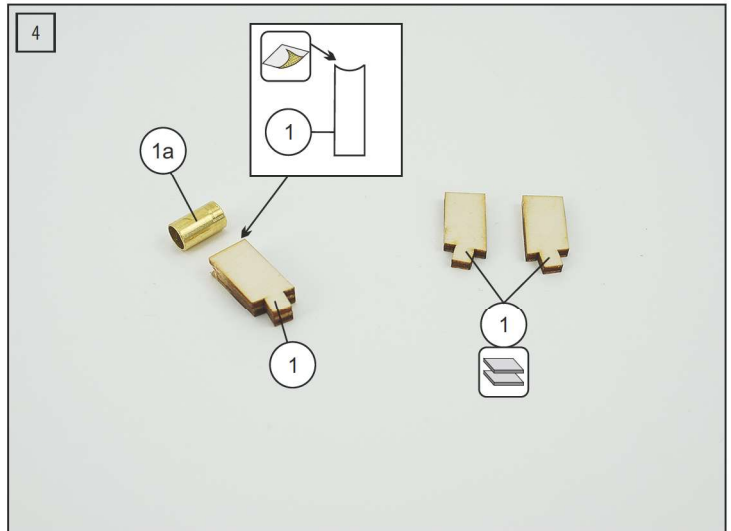
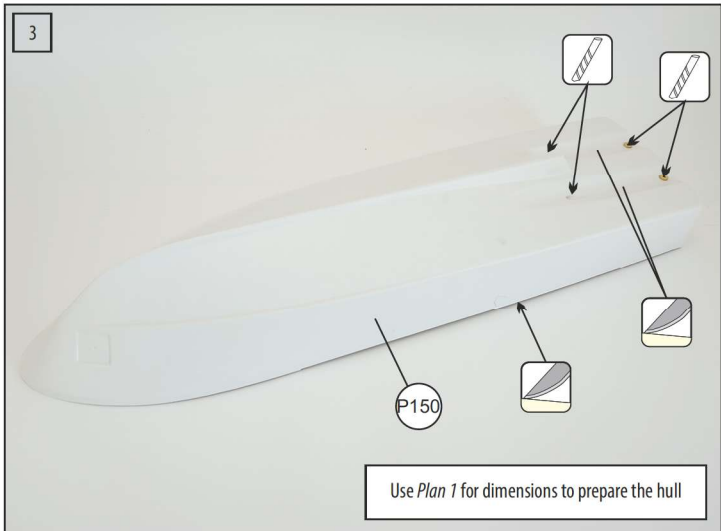
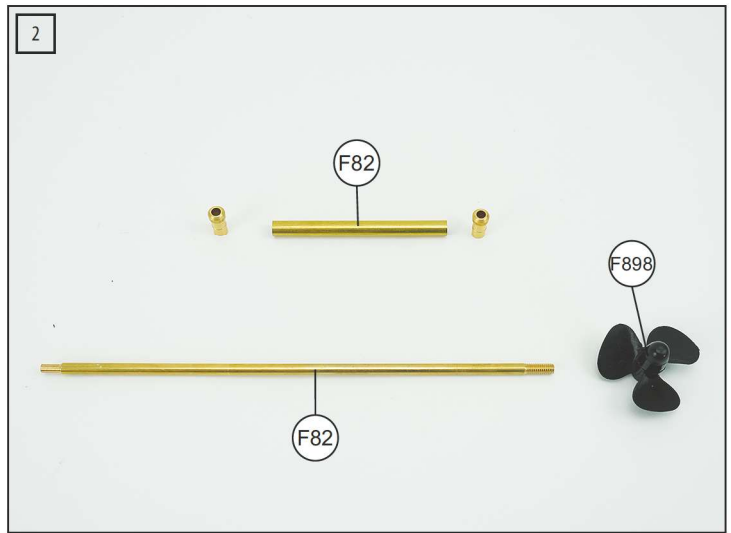
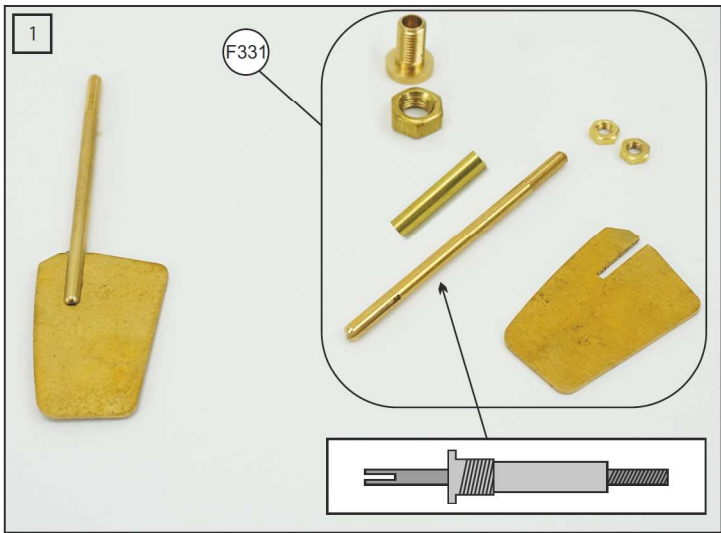

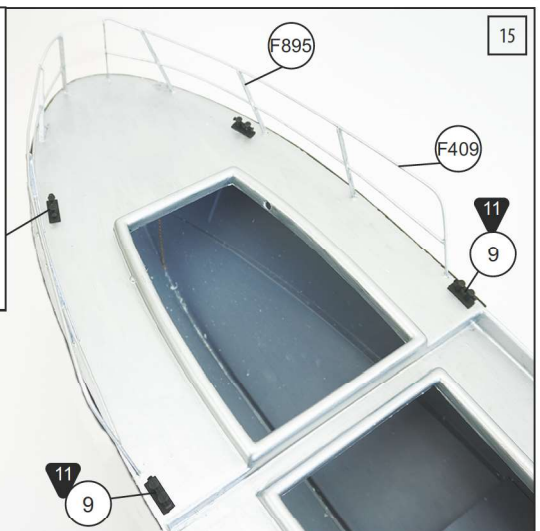
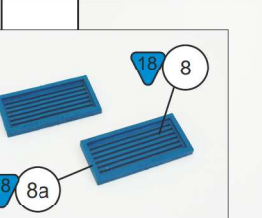
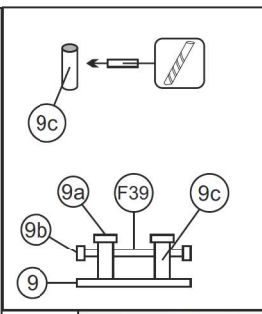
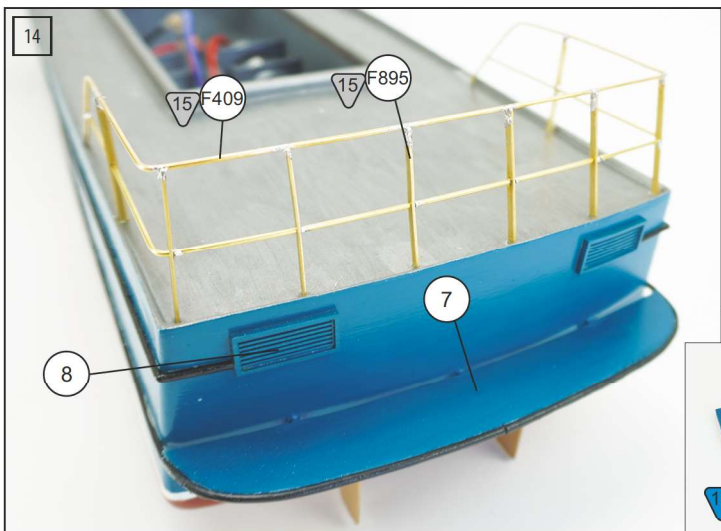
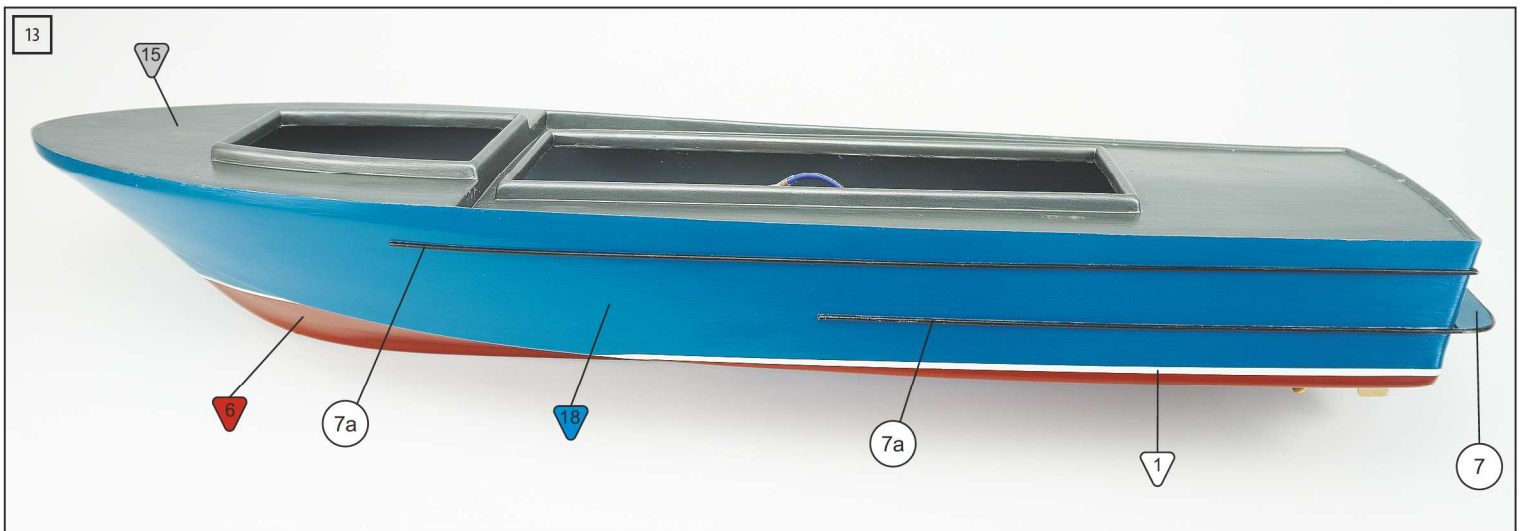
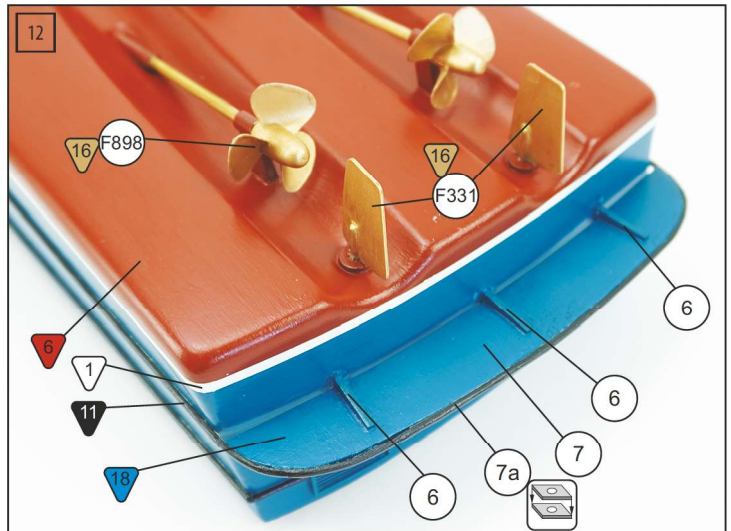
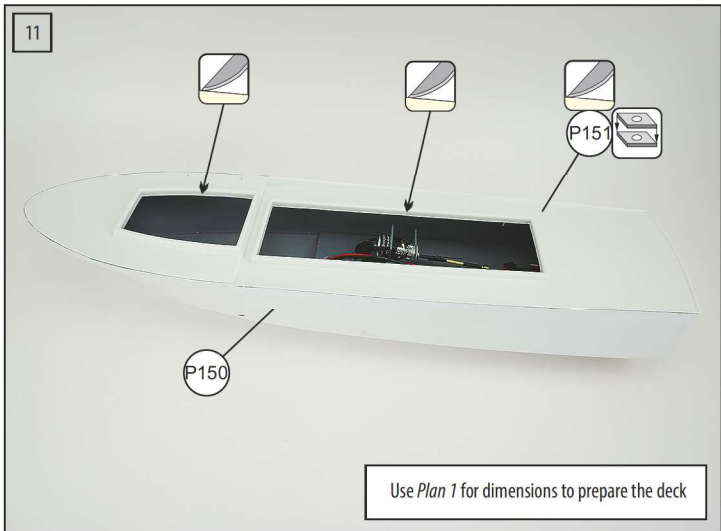
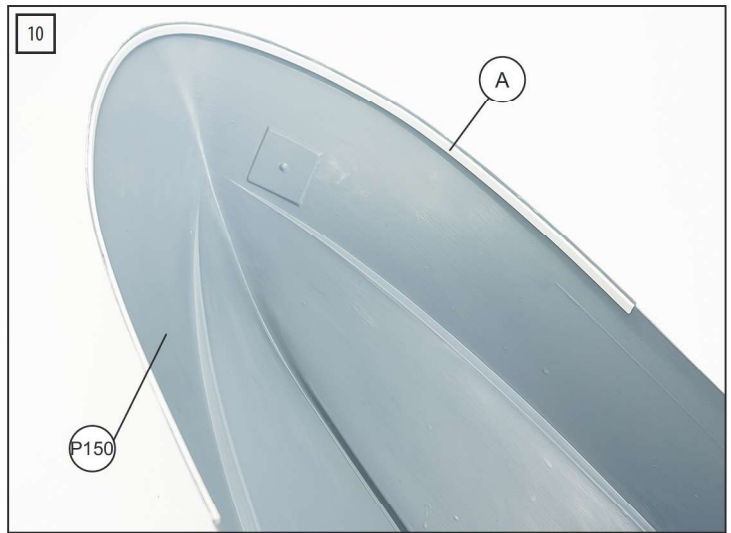
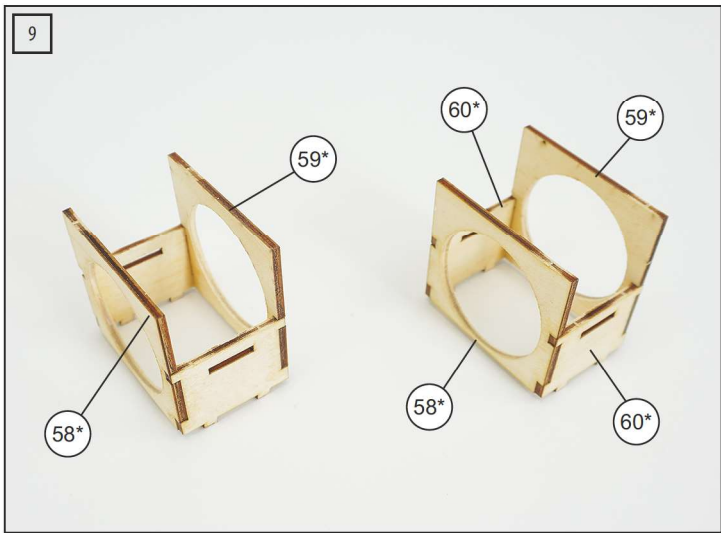

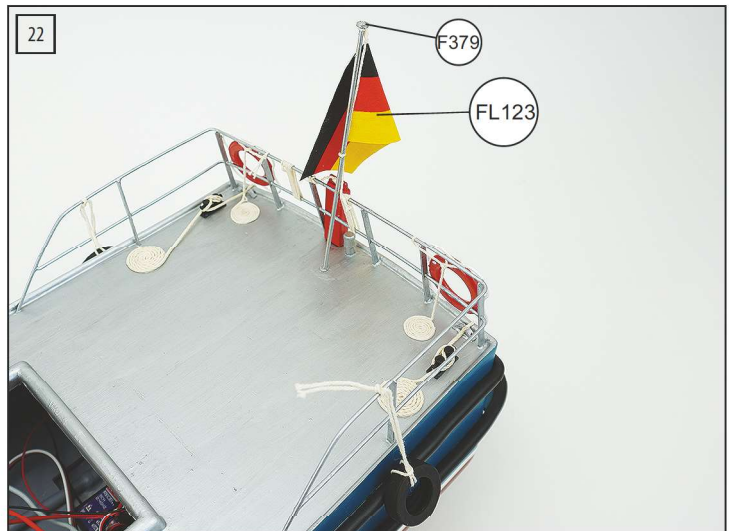
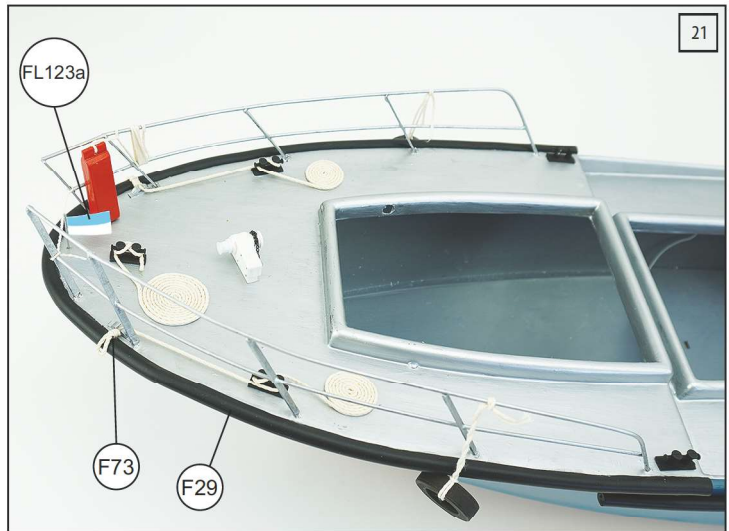
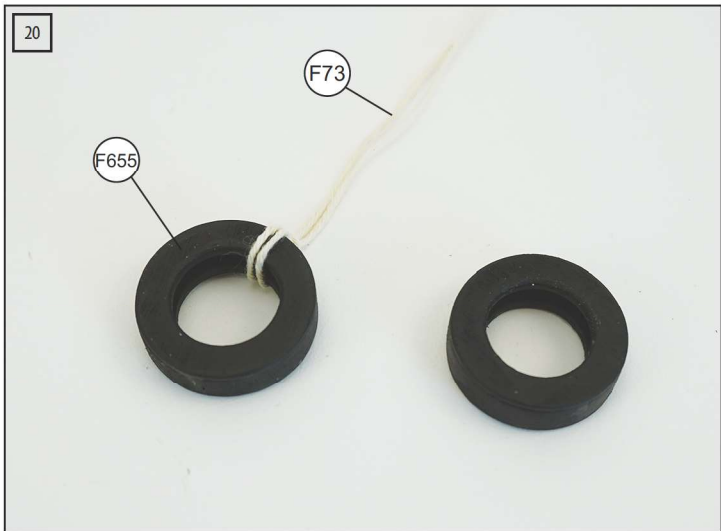
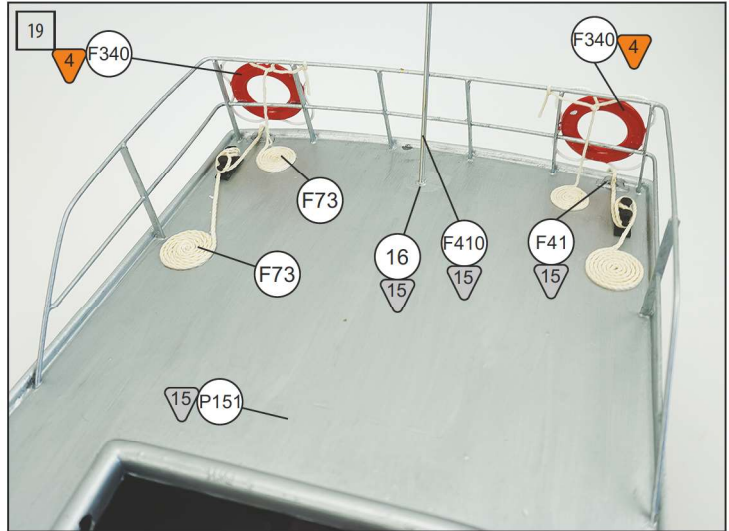
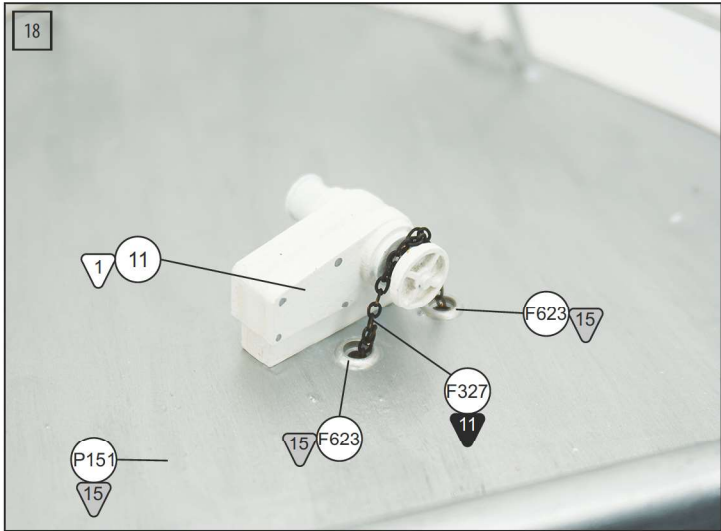
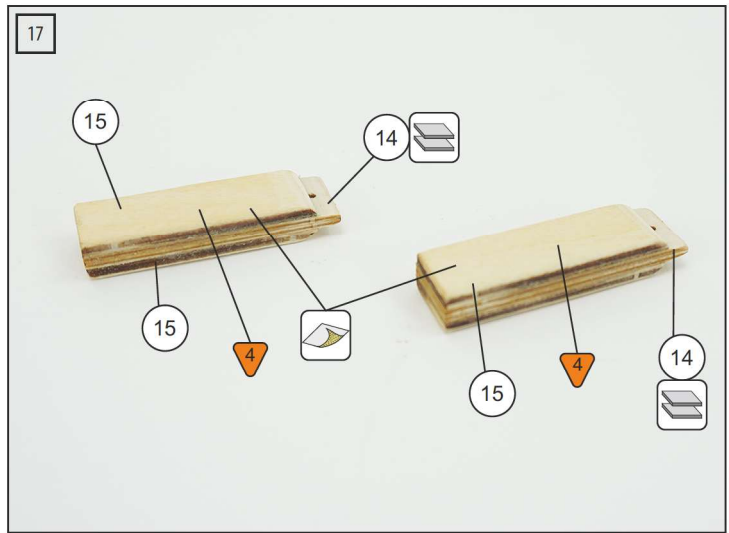
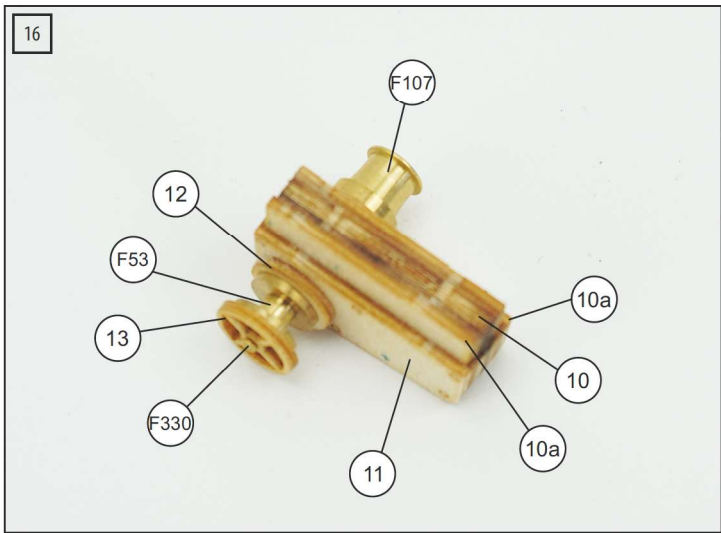

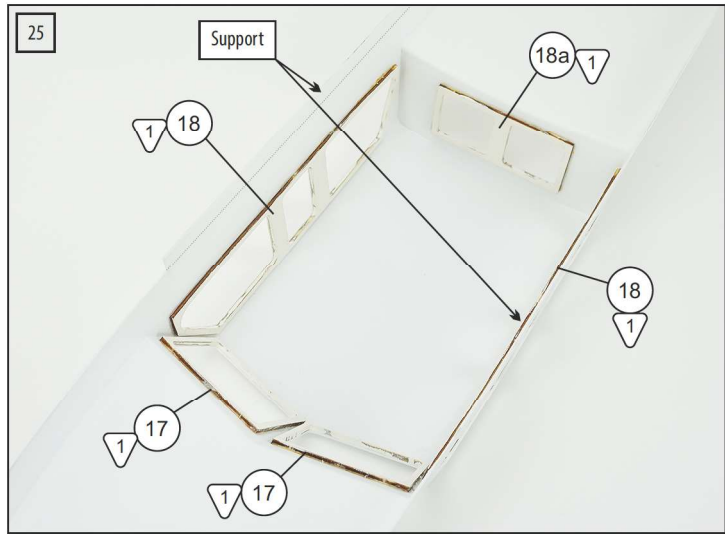
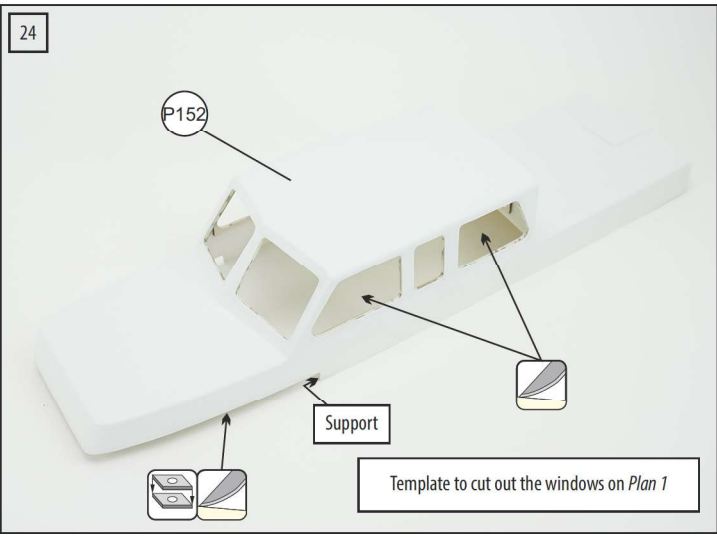
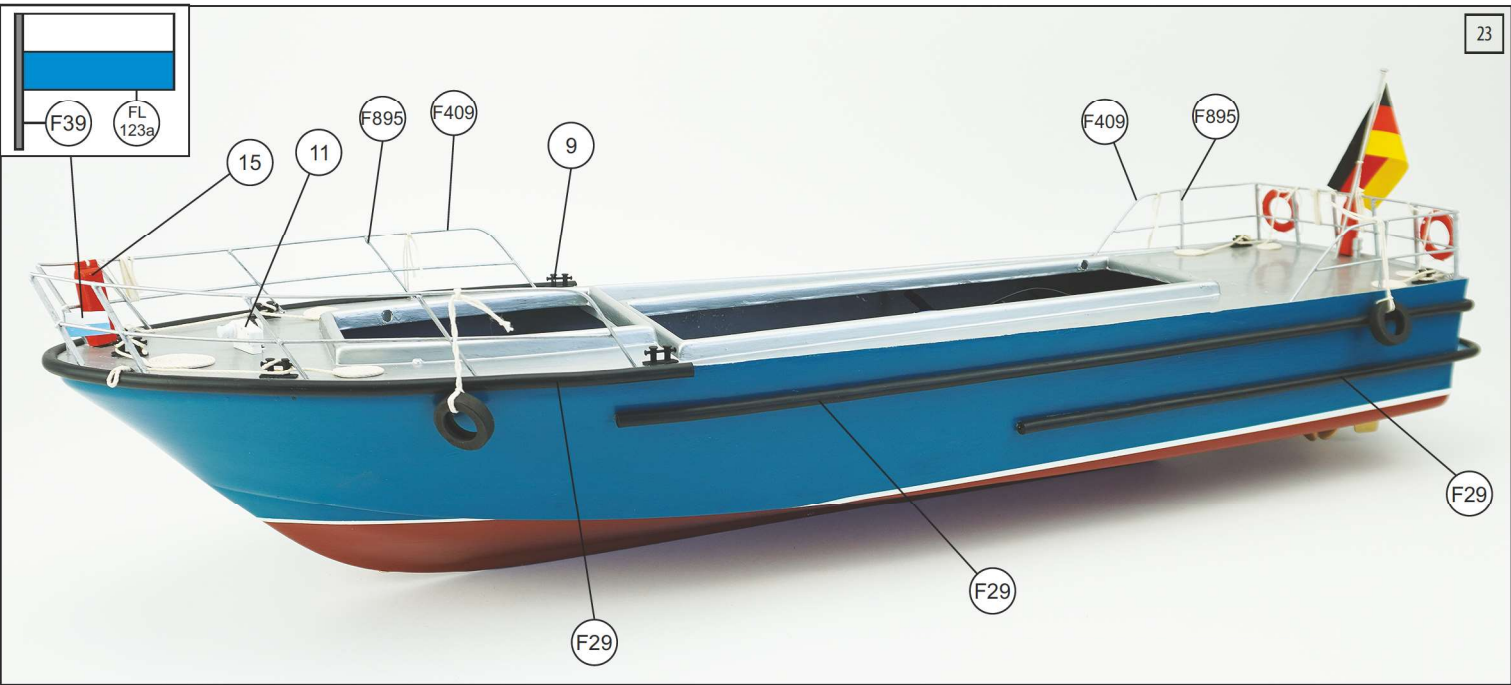

1. Spare material from part P151 can be used as a support for part P152. Support place is shown on the photo 24 and 25.  
 2. To cut out the windows as a template can also be used window parts (17, 18, 18a).

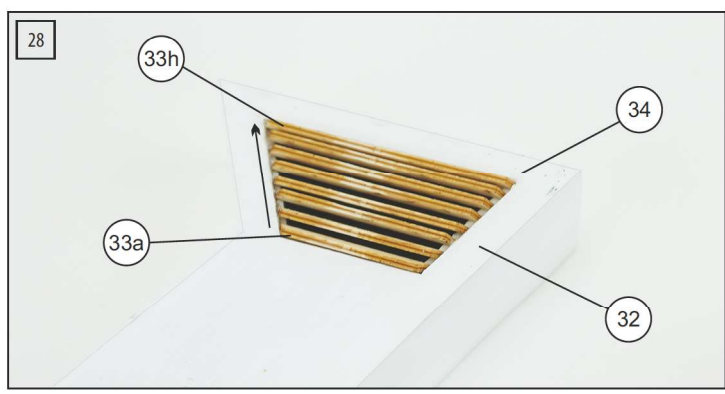
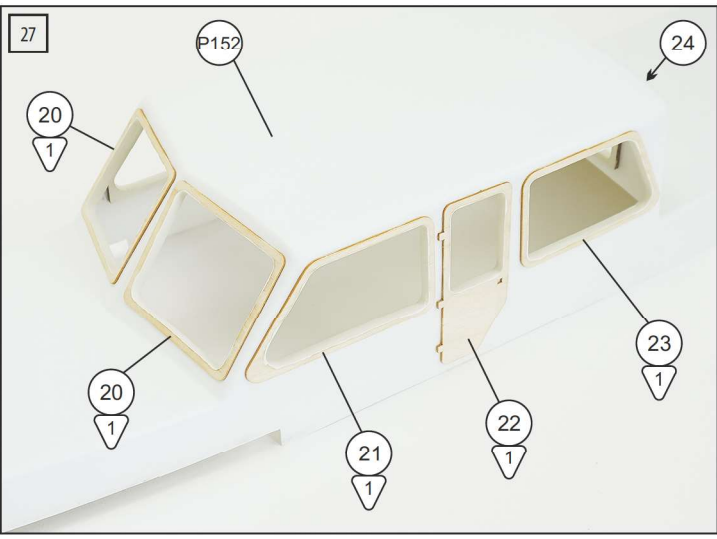
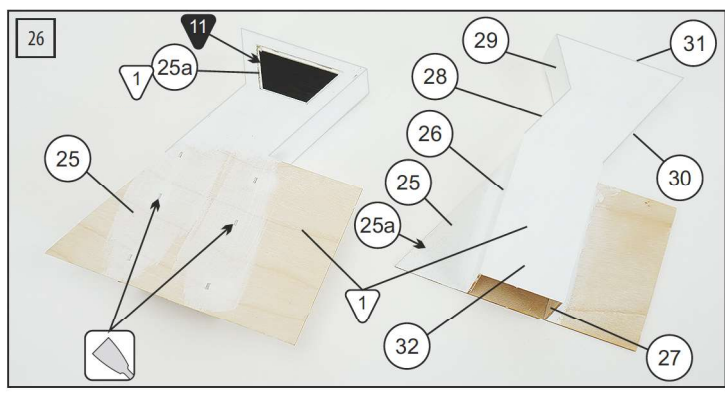

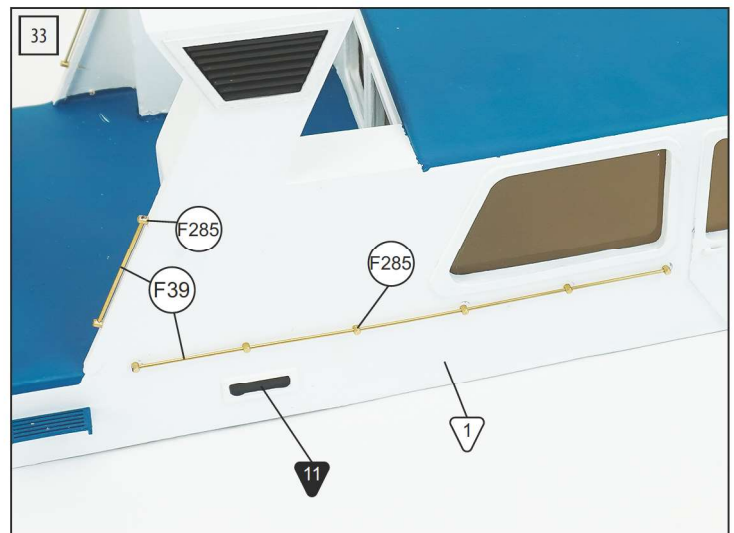
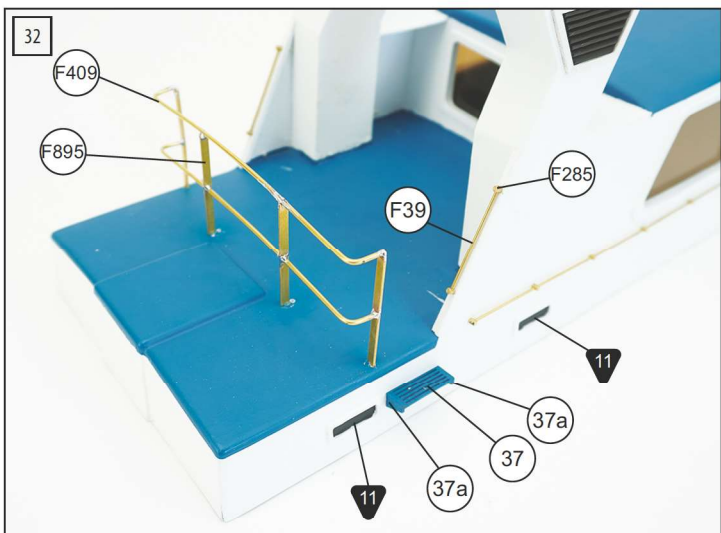
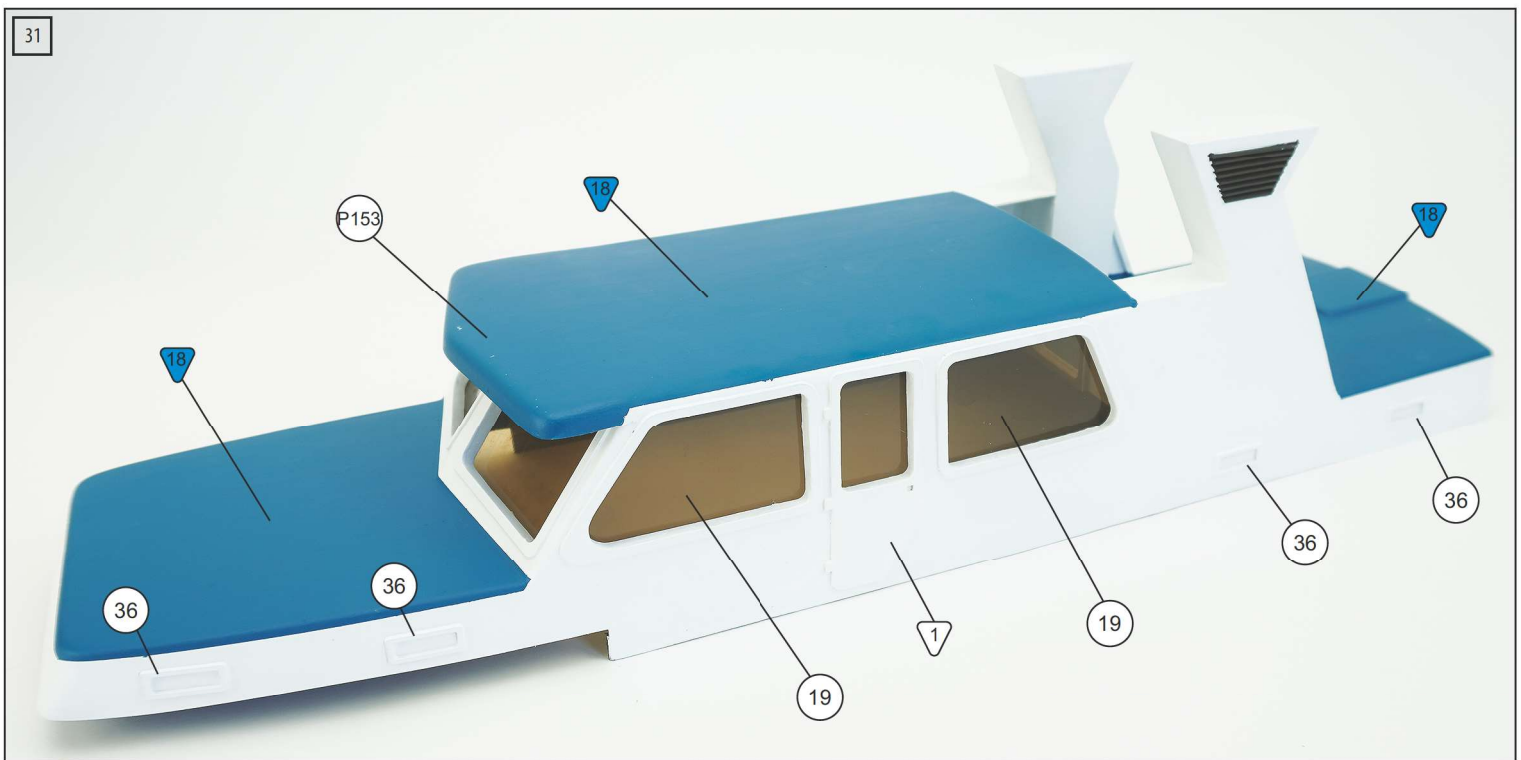
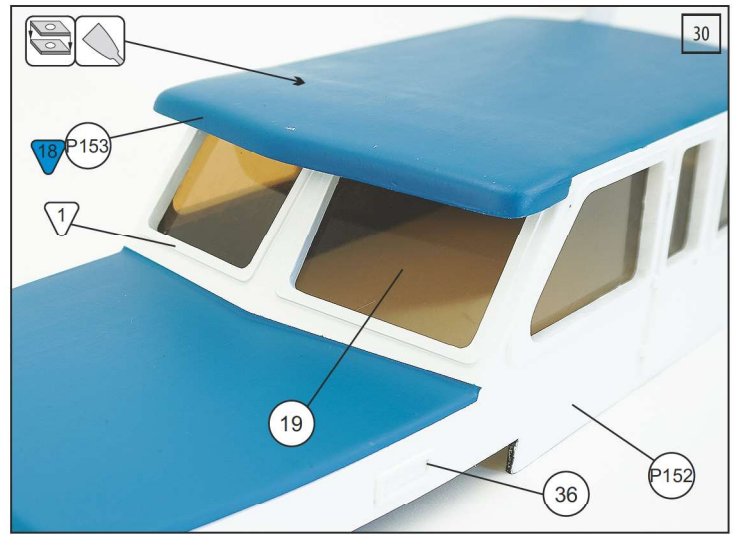
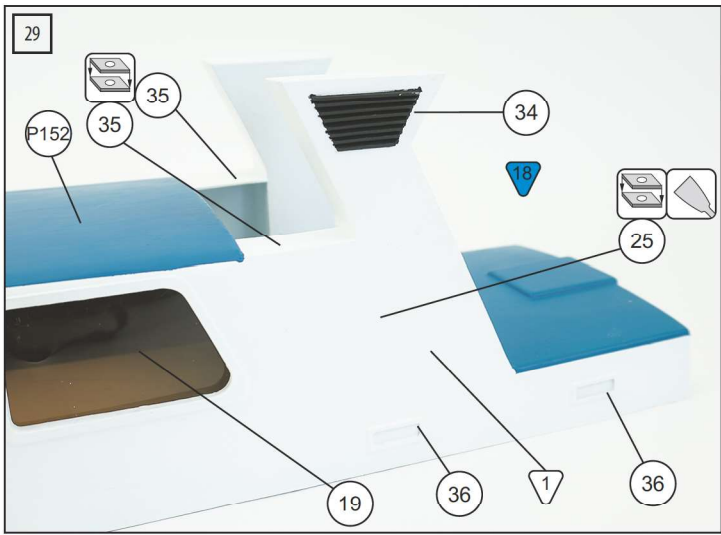

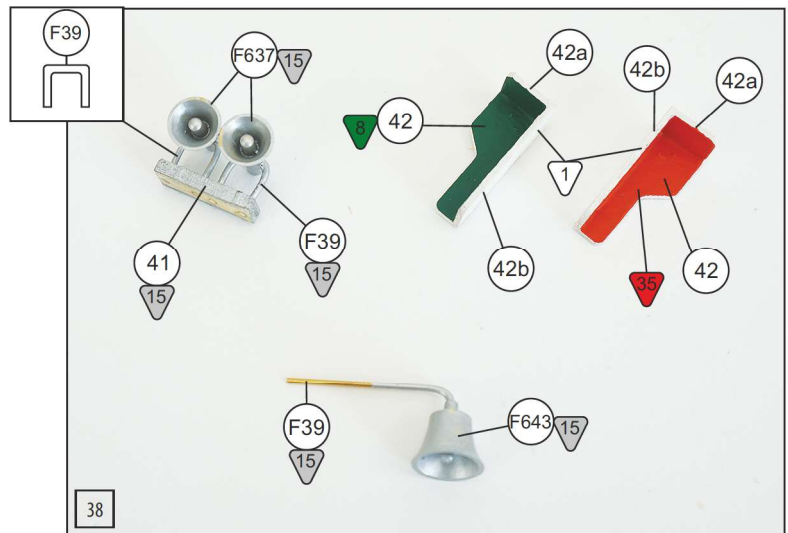
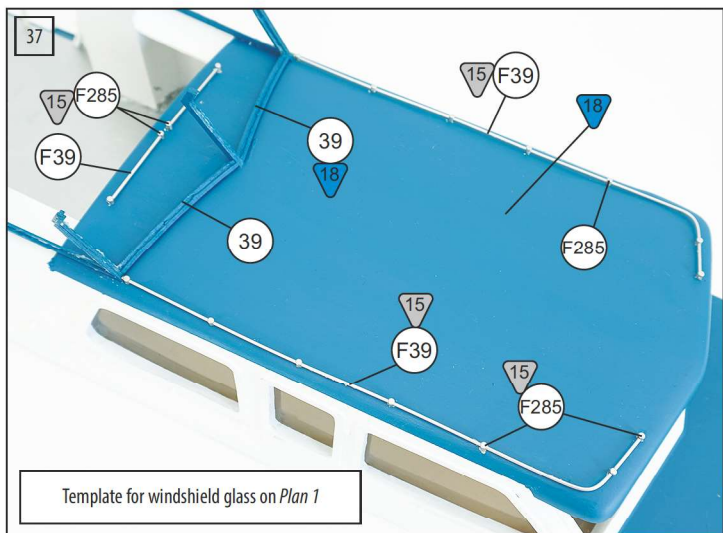
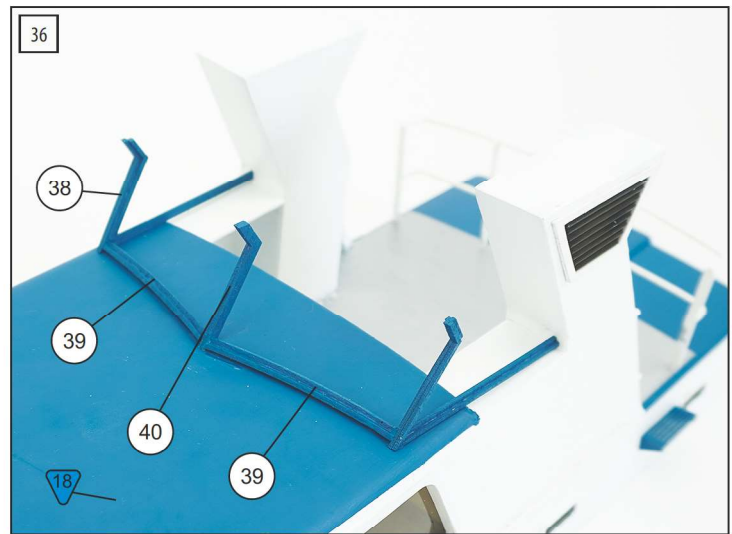
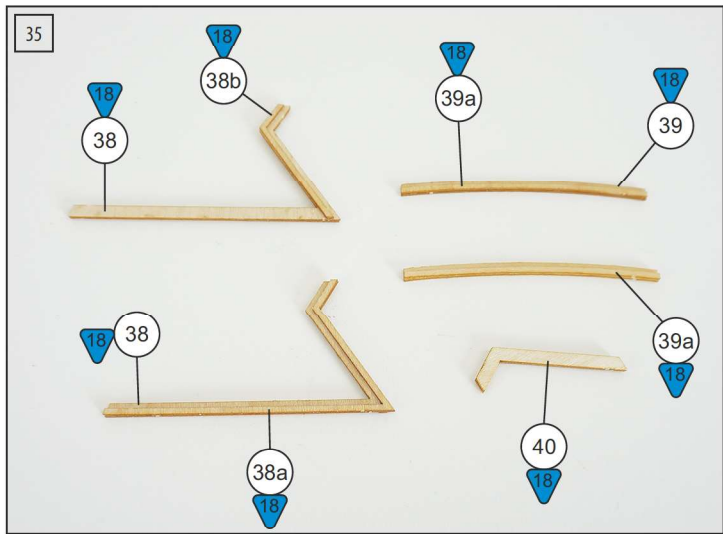
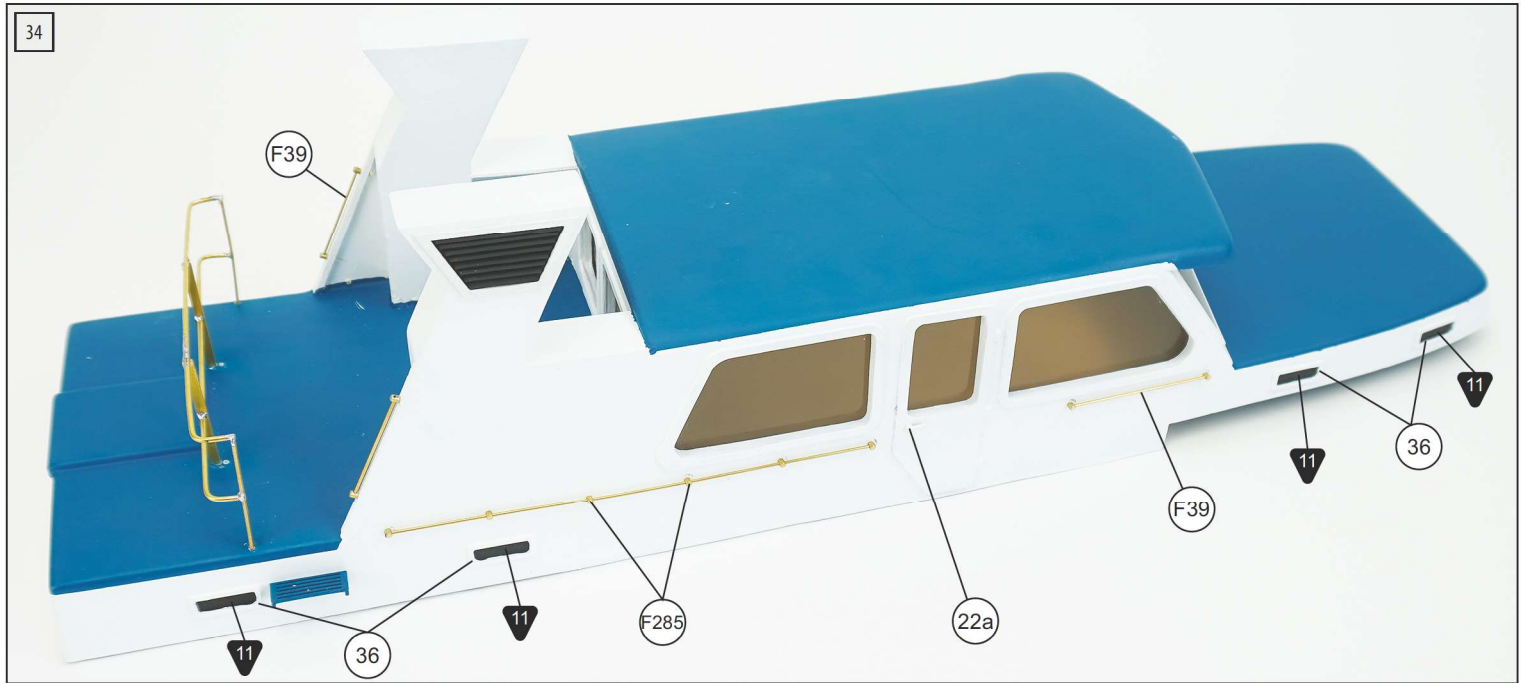



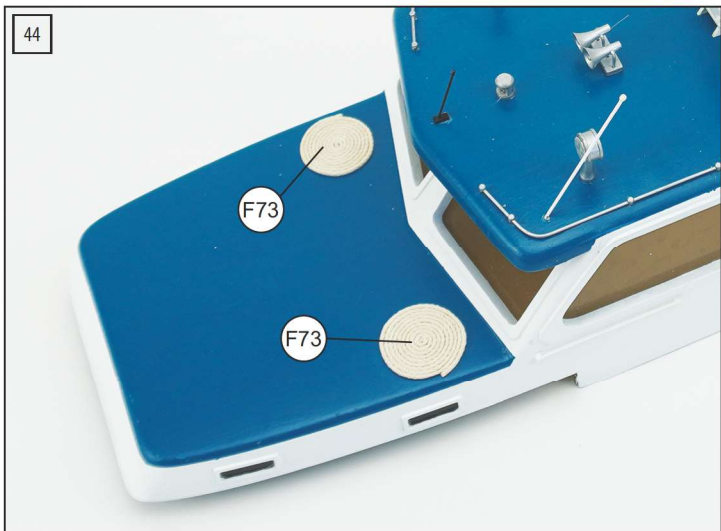
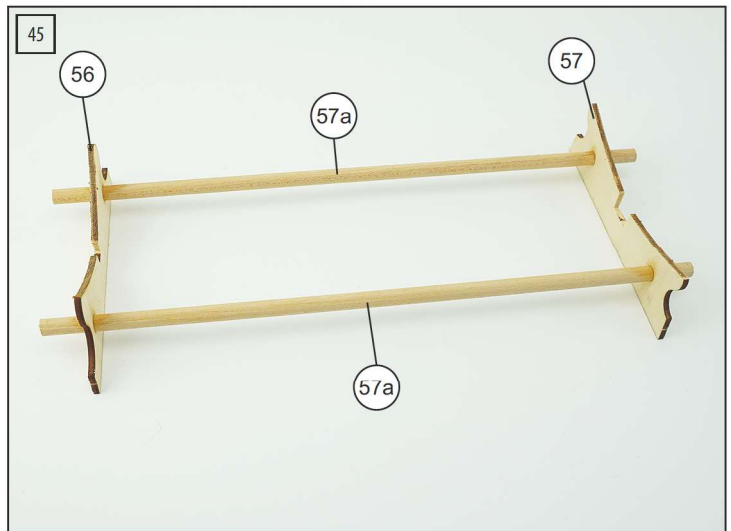
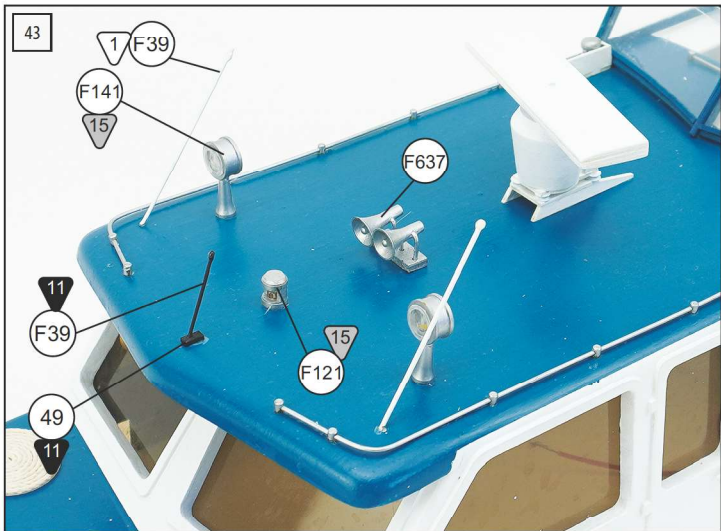
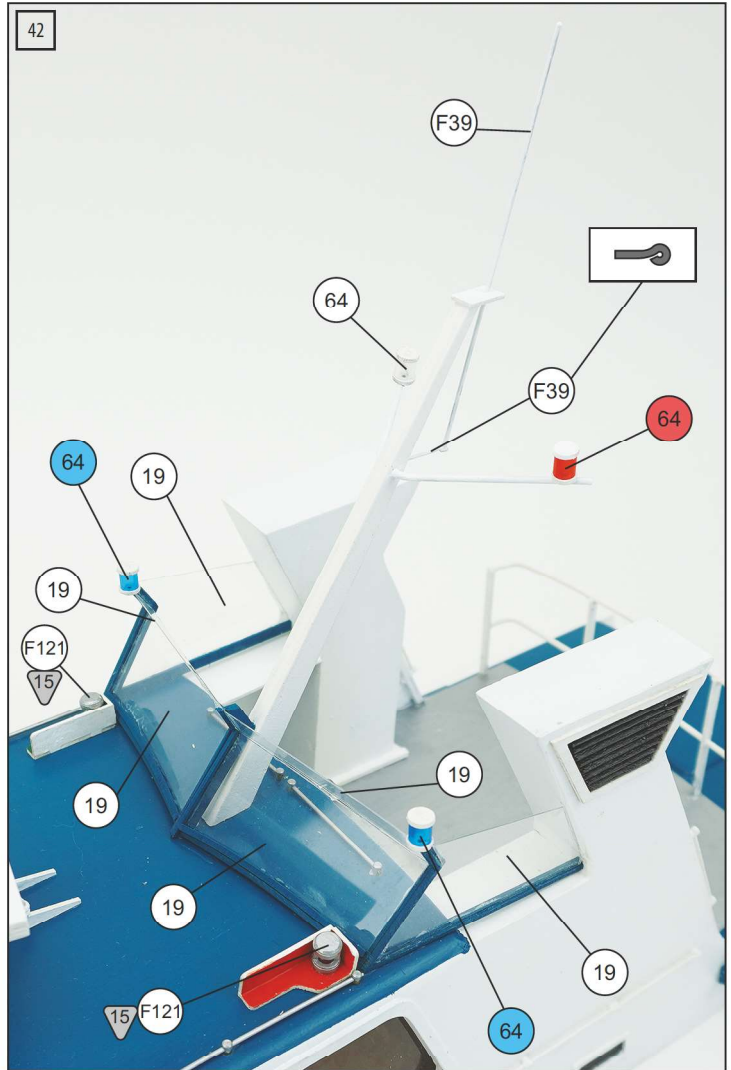
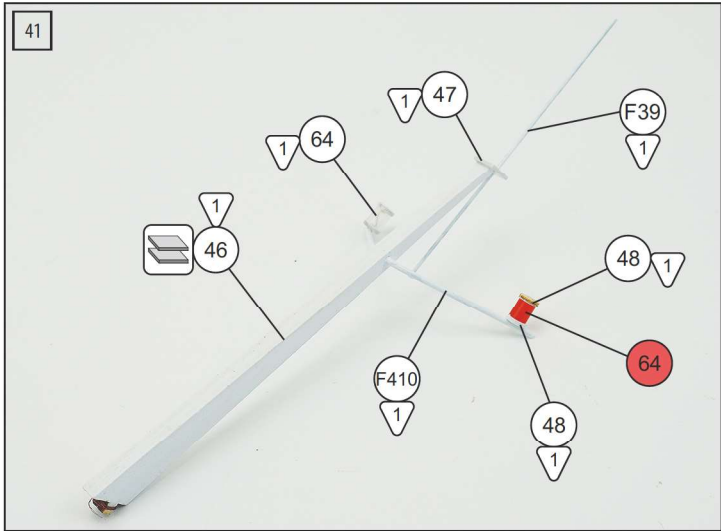
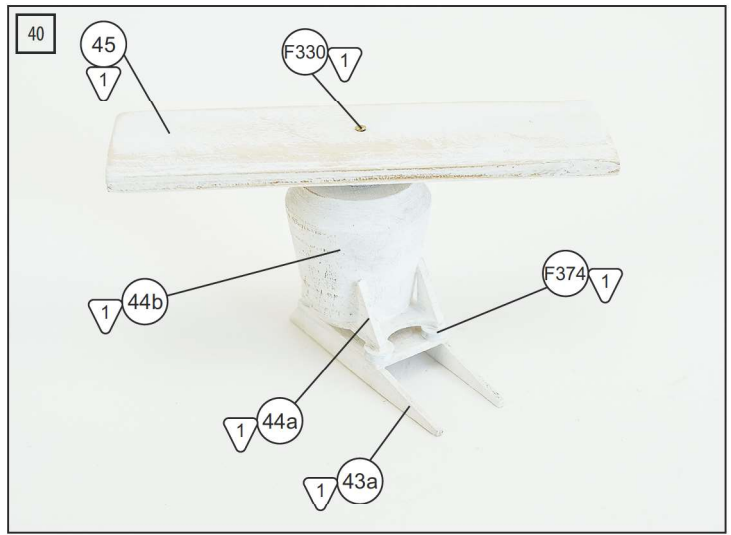
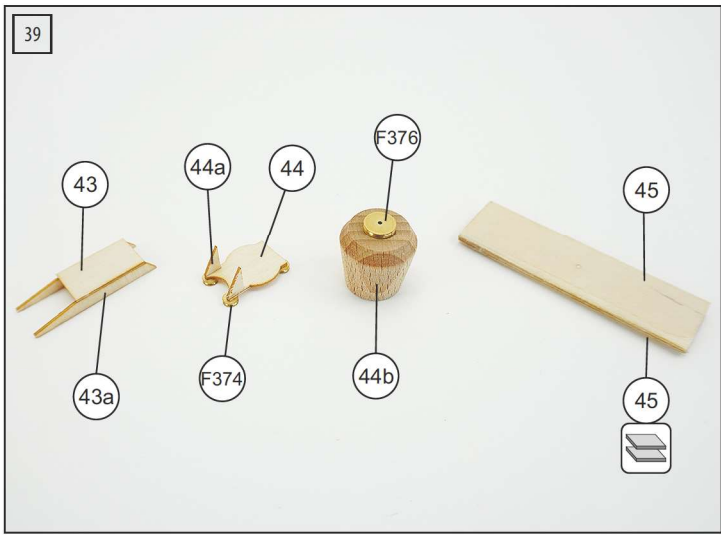

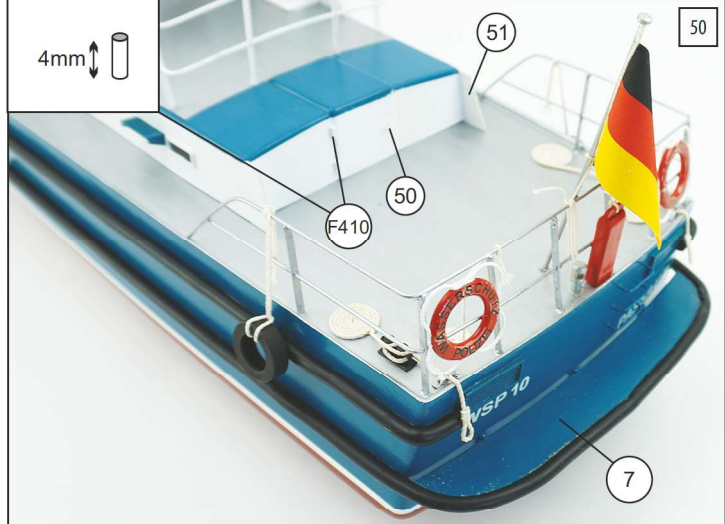
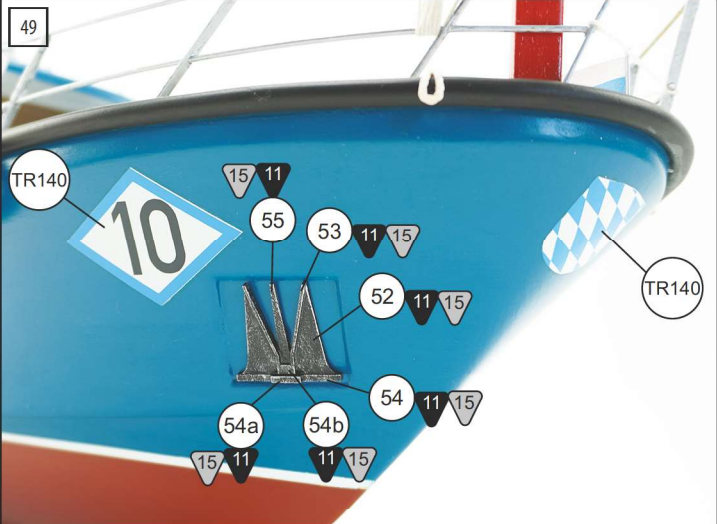
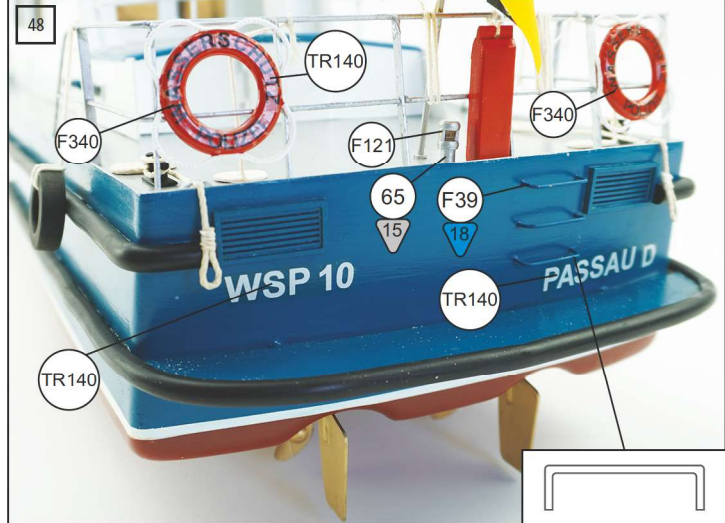
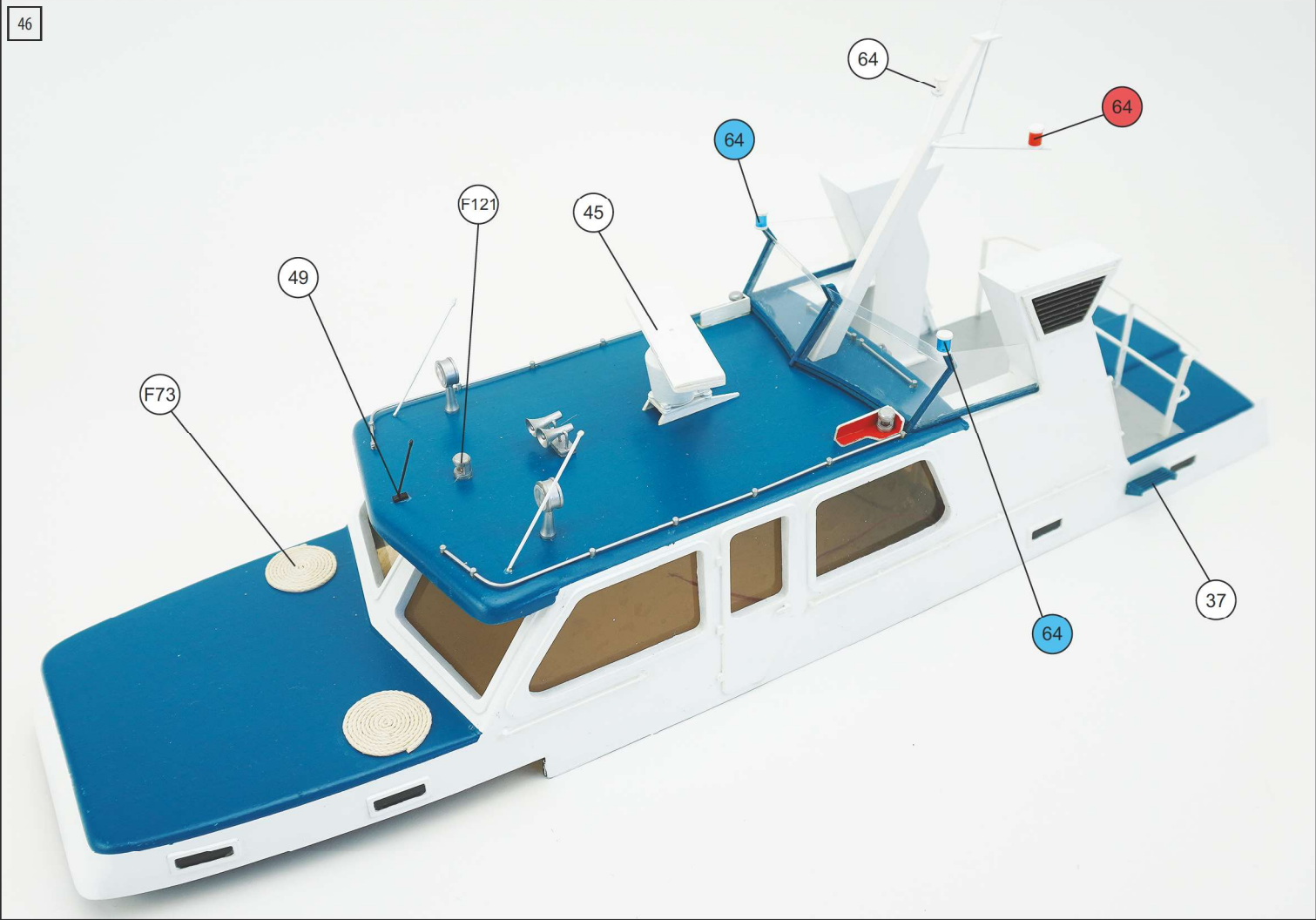



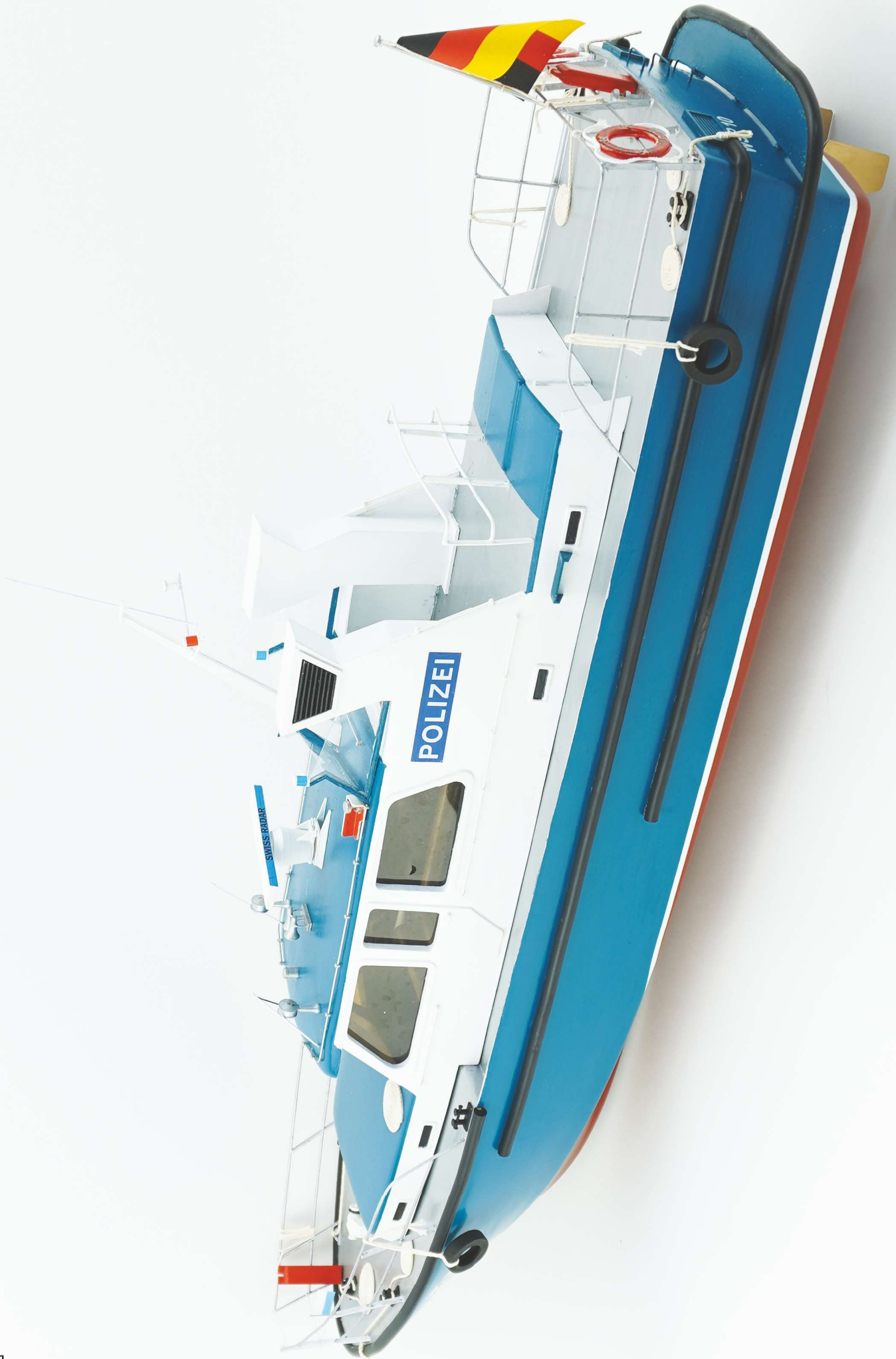

# RC ACCESSORIES

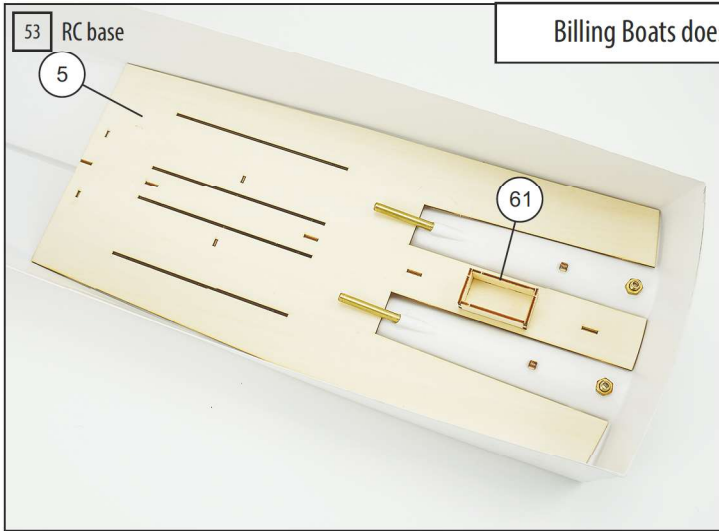

Billing Boats does not offer support for RC.

Servo support  
Orientation depends of servo



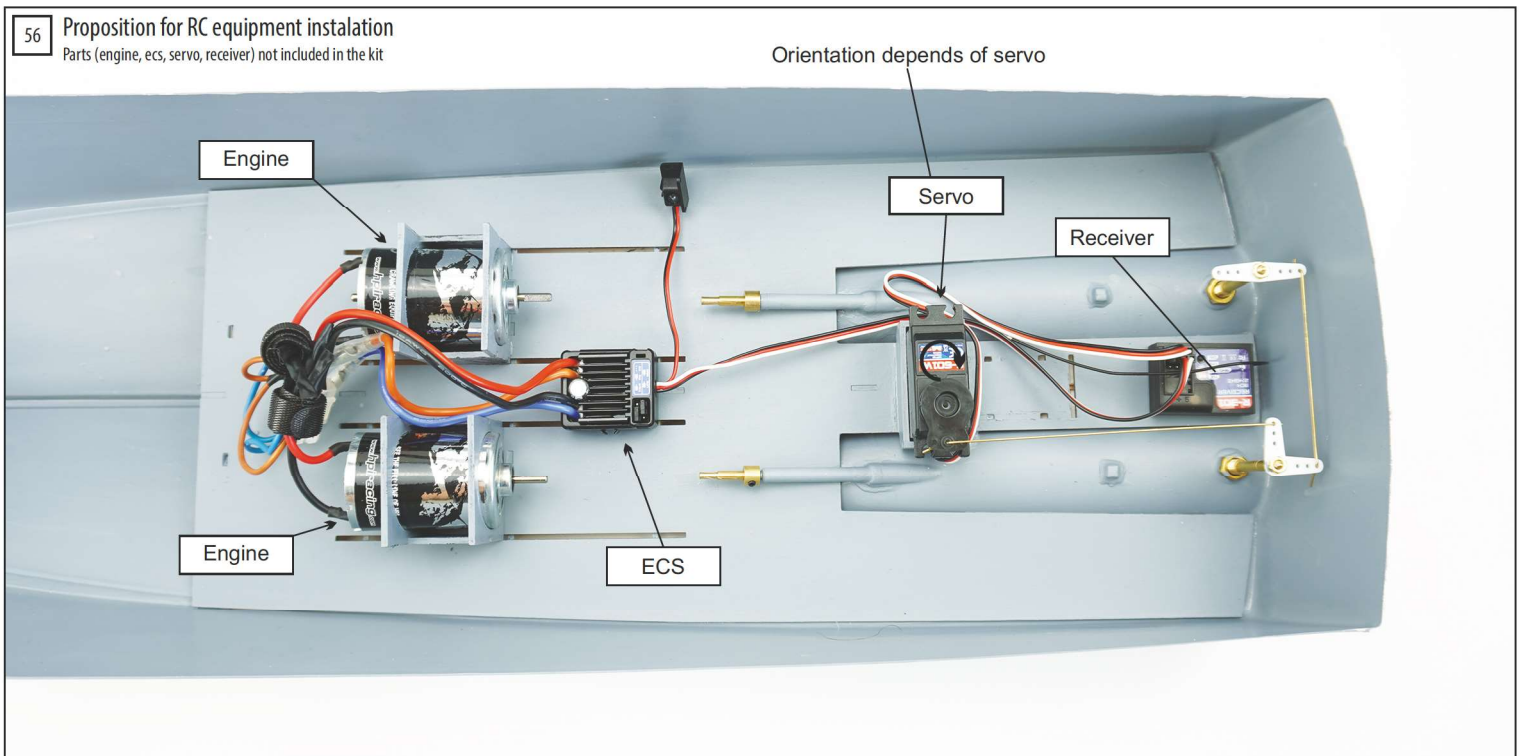
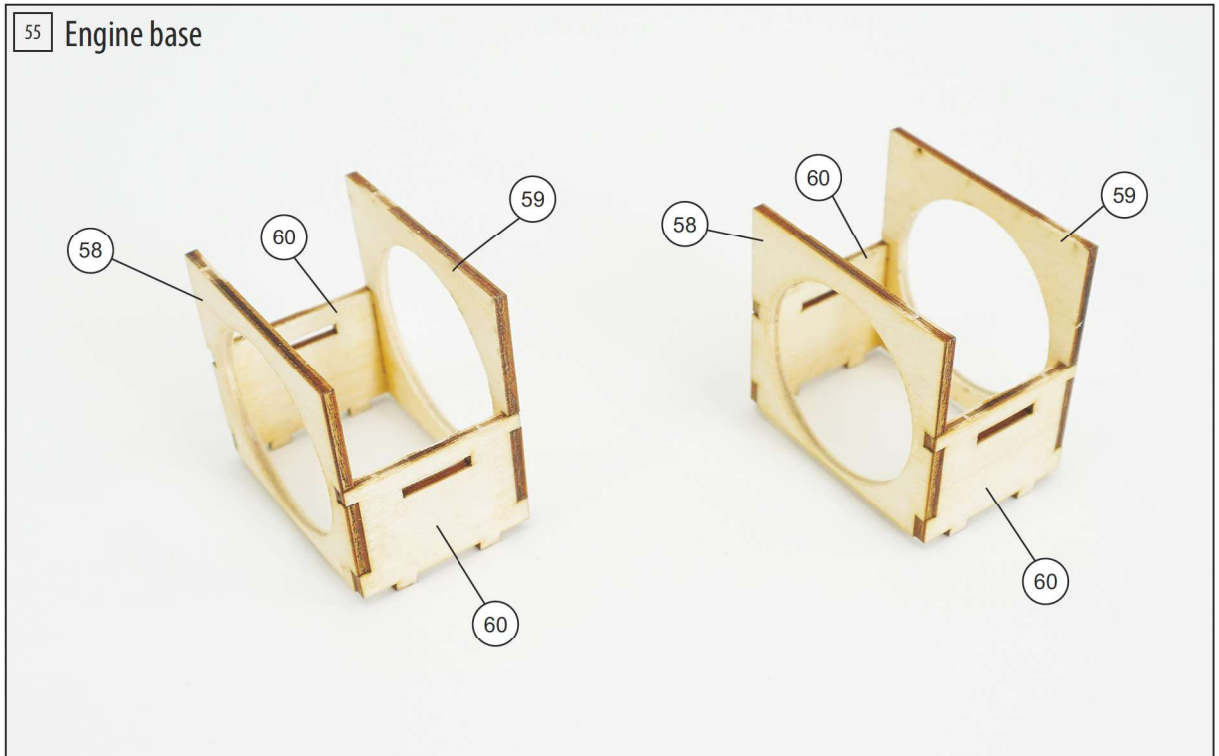
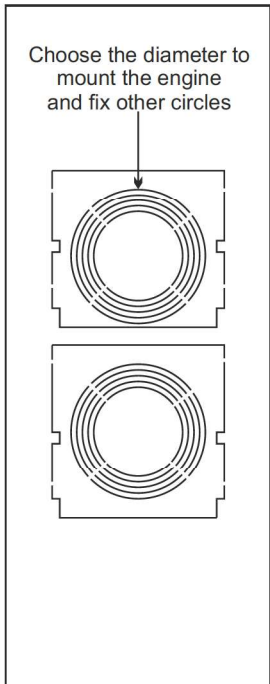
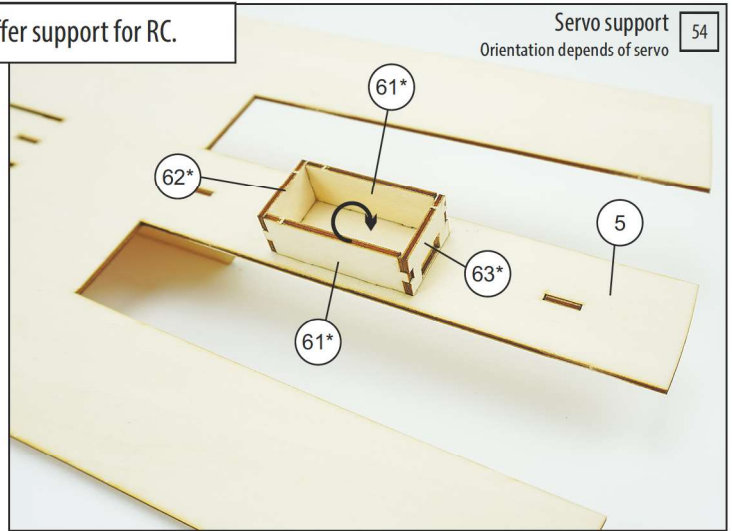

54



57 Lights on WSP 10



Before assembling lights please choose connection method.  
Billing Boats does not offer support for RC/electronics.

-  White
-  Red
-  Green
-  Blue

58



2169L

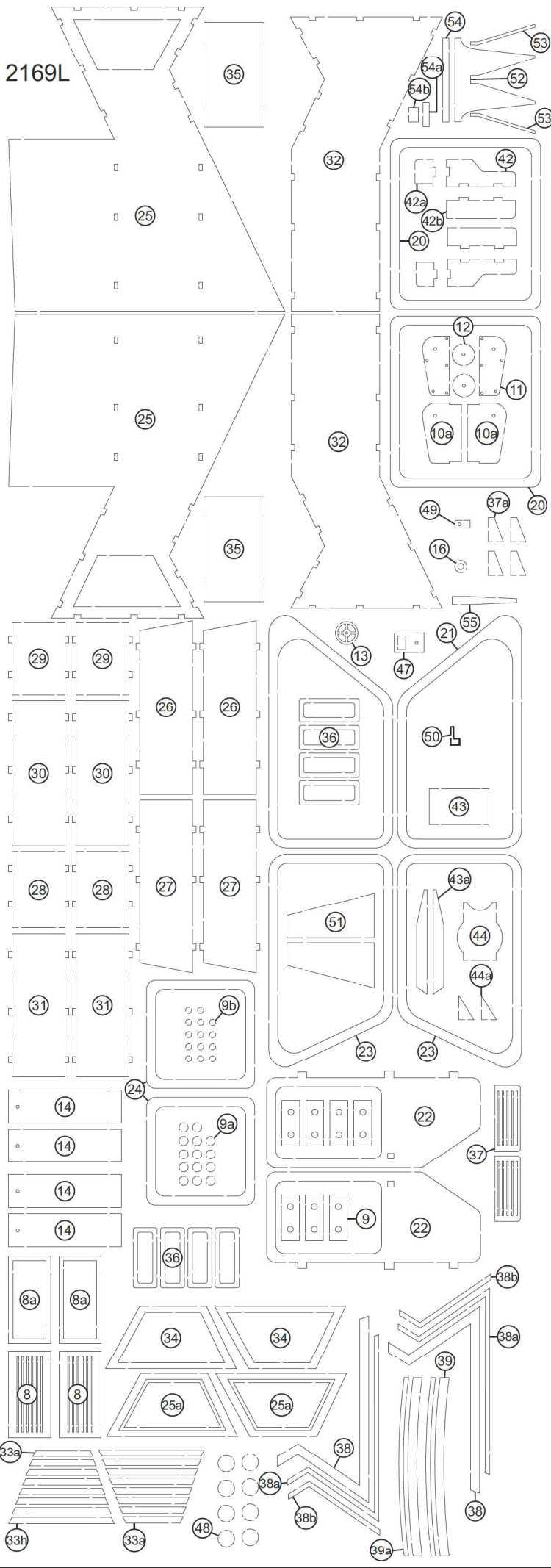

2170L

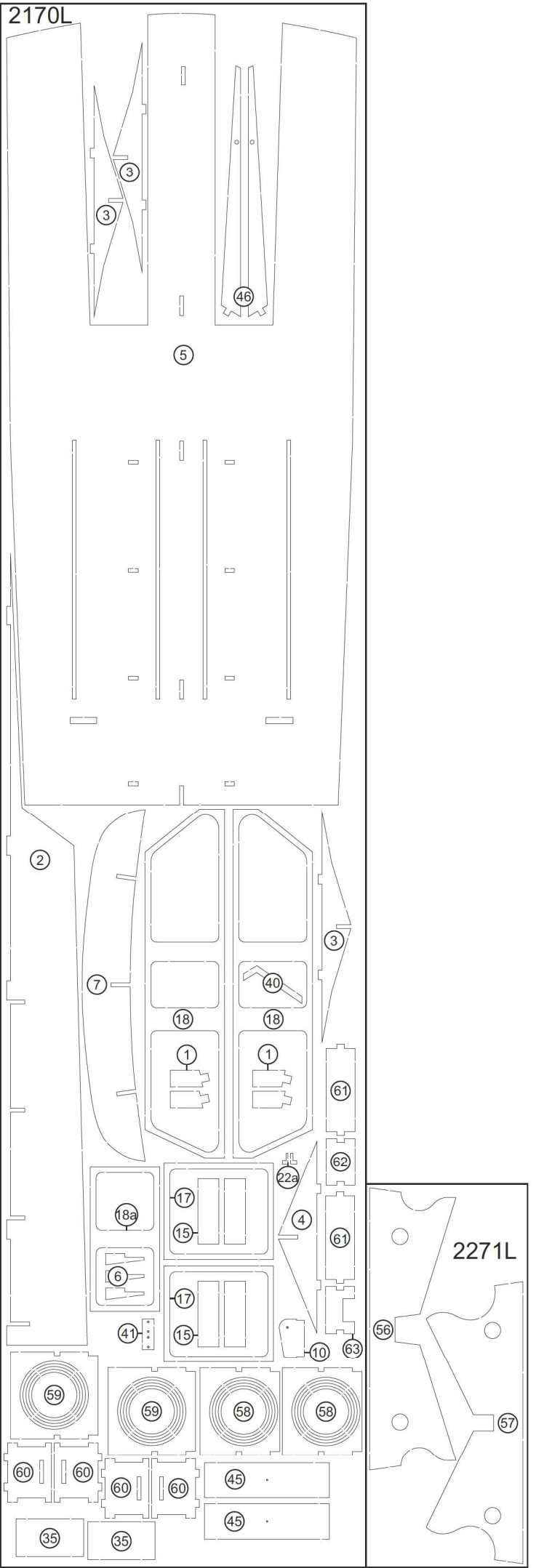

**Table of contents for WSP 10 Art. No. 408**

<b>Pcs.</b>	<b>No.</b>	<b>Dimension</b>	<b>Material</b>	<b>Found in</b>	<b>DK</b>	<b>GB</b>	<b>D</b>	<b>F</b>	<b>NL</b>
1	P150		Plastic		Skrog	Hull	Rumpf	Coque	Romp
1	P151		Plastic		Dæk	Deck	Deck	Pont	Dek
1	P152		Plastic		Kahyt	Cabin	Kajüte	Cabine	Kajuit
1	P153		Plastic		Tag	Roof	Dach	Toit	Dak
1	A	1,5x4x600mm	Plastic	LB	Liste	Strip	Leiste	Baguette	Strip
4	1	2 mm x-veneér	2170L	LAS	Aksel support	Shaft support	Welle stützen	Hélice support	Winchfás steun
2	1a	ø6x9mm	Brass	BF-B	Aksel support	Shaft support	Welle stützen	Hélice support	Winchfás steun
1	2	2 mm x-veneér	2170L	LAS	RC Platform	RC Platform	RC Platform	RC Platform	RC Platform
3	3	2 mm x-veneér	2170L	LAS	RC Platform	RC Platform	RC Platform	RC Platform	RC Platform
1	4	2 mm x-veneér	2170L	LAS	RC Platform	RC Platform	RC Platform	RC Platform	RC Platform
1	5	2 mm x-veneér	2170L	LAS	RC Platform	RC Platform	RC Platform	RC Platform	RC Platform
3	6	2 mm x-veneér	2170L	LAS	Support	Support	Stützen	Support	Steun
1	7	2 mm x-veneér	2170L	LAS	Deck	Deck	Deck	Pont	Dek
4	7a	1,8x2x600mm	Obechi	LB	Liste	Strip	Leiste	Baguette	Strip
2	8	1 mm x-veneér	2169L	LAS	Ventil	Vent	Lüfter	Manche á air	Luchtkokker
2	8a	1 mm x-veneér	2169L	LAS	Ventil	Vent	Lüfter	Manche á air	Luchtkokker
7	9	1 mm x-veneér	2169L	LAS	Klampe	Cleat	Klampe	Taquet	Klamp
14	9a	1 mm x-veneér	2169L	LAS	Klampe	Cleat	Klampe	Taquet	Klamp
14	9b	1 mm x-veneér	2169L	LAS	Klampe	Cleat	Klampe	Taquet	Klamp
14	9c	ø2x50mm	Wood	LB	Klampe	Cleat	Klampe	Taquet	Klamp
1	10	2 mm x-veneér	2170L	LAS	Capstan	Capstan	Capstan	Cabestan	Kaapstander
2	10a	1 mm x-veneér	2169L	LAS	Capstan	Capstan	Capstan	Cabestan	Kaapstander
2	11	1 mm x-veneér	2169L	LAS	Capstan	Capstan	Capstan	Cabestan	Kaapstander
2	12	1 mm x-veneér	2169L	LAS	Capstan	Capstan	Capstan	Cabestan	Kaapstander
1	13	1 mm x-veneér	2169L	LAS	Capstan	Capstan	Capstan	Cabestan	Kaapstander
4	14	1 mm x-veneér	2169L	LAS	Bøje	Buoy	Boje	Bouée	Boei
4	15	2 mm x-veneér	2170L	LAS	Bøje	Buoy	Boje	Bouée	Boei
1	16	2 mm x-veneér	2170L	LAS	Support	Support	Stützen	Support	Steun
2	17	1 mm x-veneér	2169L	LAS	Vindue	Window	Fenster	Fenêtre	Raam
2	18	1 mm x-veneér	2169L	LAS	Vindue	Window	Fenster	Fenêtre	Raam
1	18a	1 mm x-veneér	2169L	LAS	Vindue	Window	Fenster	Fenêtre	Raam
1	19		Foil	LAS	Vindue	Window	Fenster	Fenêtre	Raam
10	20-24	1 mm x-veneér	2169L	LAS	Vindue	Window	Fenster	Fenêtre	Raam
4	22a, 25a	2 mm x-veneér	2170L	LAS	Håndtag	Handle	Handrad	Mainevelle	Handspaak
18	25 – 32	1 mm x-veneér	2169L	LAS	Skorsten	Chimney	Schornstein	Cheminée	Schoorsteen
16	33a – 33h	1 mm x-veneér	2169L	LAS	Skorsten	Chimney	Schornstein	Cheminée	Schoorsteen
2	34	1 mm x-veneér	2169L	LAS	Skorsten	Chimney	Schornstein	Cheminée	Schoorsteen
2	35	1 mm x-veneér	2169L	LAS	Support	Support	Stützen	Support	Steun
2	35	2 mm x-veneér	2170L	LAS	Support	Support	Stützen	Support	Steun
8	36	1 mm x-veneér	2169L	LAS	Vindue	Window	Fenster	Fenêtre	Raam
6	37-37a	1 mm x-veneér	2169L	LAS	Trappe	Stairs	Treppe	Escalier	Trap
10	38-39	1 mm x-veneér	2169L	LAS	Ramme	Frame	Rahmen	Cadre	Kader
1	40	2 mm x-veneér	2170L	LAS	Ramme	Frame	Rahmen	Cadre	Kader
1	41	2 mm x-veneér	2170L	LAS	Sokkel	Base	Socket	Socle	Sokkel



Pes.	No.	Dimension	Material	Found in	DK	GB	D	F	NL
6	42-42b	1 mm x-veneér	2169L	LAS	Lampe Sokkel	Lamp Base	Lampen Sokkel	Lampe – Socle	Lamp – Sokkel
6	43-44	1 mm x-veneér	2169L	LAS	Radar	Radar	Radar	Radar	Radar
2	45	2 mm x-veneér	2170L	LAS	Radar	Radar	Radar	Radar	Radar
2	46	2 mm x-veneér	2170L	LAS	Mærsstang	Mast	Mast	Mât	Mast
1	47	1 mm x-veneér	2169L	LAS	Support	Support	Stützen	Support	Steun
8	48	1 mm x-veneér	2169L	LAS	Lampe	Lamp	Lampen	Lampe	Lamp
1	49	1 mm x-veneér	2169L	LAS	Support	Support	Stützen	Support	Steun
1	50	1 mm x-veneér	2169L	LAS	Håndtag	Handle	Handrad	Mainevelle	Handspaak
2	51	1 mm x-veneér	2169L	LAS	Support	Support	Stützen	Support	Steun
7	52-55	1 mm x-veneér	2169L	LAS	Anker	Anchor	Anker	Ancre	Anker
2	56-57	3 mm x-veneér	2271L	LAS	Sokkel	Base	Sokkel	Socle	Sokkel
8	58-60	2 mm x-veneér	2170L	LAS	RC Support	RC Support	RC Stützen	RC Support	RC Steun
4	61-63	2 mm x-veneér	2170L	LAS	RC Support	RC Support	RC Stützen	RC Support	RC Steun
4	64				Stift	Pin	Stift	Clous	Spijkertjes
1	65	ø6x9mm	Brass		Sokkel	Base	Sokkel	Socle	Sokkel
6	F39	ø1,0x250mm	Brass	MS	Messingtråd	Brass wire	Messingdråht	Fils de laiton	Messingdraad
4	F41	12mm	Plastic	BF-A	Klampe	Cleat	Klampe	Taquet	Klampe
2	F29	ø6	Rubber	TS	Gummibånd	Rubberband	Gummiband	Elastique	Elastiek
1	F53	ø6mm	Brass	BF-B	Rulle	Roll	Rolle	Poulie	Rollen
1	F73	3m	Thread	TS	Ræb	Rope	Seil	Cordage	Touw
2	F82	ø4x170mm	Brass	MS, BF-B	Propel Aksel	Propeller shaft	Achse	Arbre port hélice	Schoefas
1	F107	ø6x6mm	Brass	BF-B	Capstan	Capstan	Capstan	Cabestan	Kaapstander
4	F121	ø6x7,5mm	Brass	BF-B	Agterlanterne	Stern light	Achterlanterne	Feu de poupe	Heklicht
2	F141	20mm	Brass	BF-B	Spotlight	Search light	Scheinwerf	Projecteur	Schijnwerper
38	F285	ø2x6mm	Brass	BF-B	Øjebolt	Eye bolt	Augbolzen	Pitons	Oogbout
1	F327	ø1,5x100mm	Metal	BF-B	Kæde	Chain	Kette	Chaine	Ketting
2	F330	ø1x10mm	Brass	BF-B	Søm	Nail	Nägel	Clou	Spijkertje
2	F331	80mm	Brass	BF-B	Ror	Rudder	Ruder	Gouvernail	Roer
2	F340	37x37mm	Plastic	BF-A	Redningskrans	Life ring	Retningsring	Ceinture sauvetage	Reddingsboei
4	F374	ø4mm	Brass	BF-B	Rulle	Roll	Rolle	Poulie	Rollen
1	F376	ø8mm	Brass	BF-B	Rulle	Roll	Rolle	Poulie	Rollen
1	F379	ø5x1,5mm	Brass	BF-B	Skive	Disk	Scheibe	Disque	Scheiben
6	F409	ø1,5x600mm	Brass	MS	Messingtråd	Brass wire	Messingdråht	Fils de laiton	Messingdraad
1	F410	ø2,0x250mm	Brass	MS	Messingtråd	Brass wire	Messingdråht	Fils de laiton	Messingdraad
2	F623	ø4,8mm	Brass	BF-B	Køje	Porthole	Bullauge	Hublot	Patrijspoort
2	F637	ø8x12mm	Brass	BF-B	Megafoon	Megaphone	Megaphone	Mégaphone	Megafhone
1	F643	ø10x9,5mm	Brass	BF-B	Klokke	Bell	Glocke	Cloche	Scheepbel
4	F655	ø28mm	Rubber	BF	Fender	Fender	Fender	Défence	Berghouten
20	F895		Brass	BF-B	Gelænderstøtte	Rail stanchion	Relingstøtze	Chandelier	Railingpaal
2	F898	ø35mm	Plastic	BF-A	Skibsskrue	Propeller	Schiffsschraube	Hélice	Propeller
1	FL123			VEJ	Flag	Flag	Drapeau	Vlag	Bandera
1	FL2			VEJ	Flag	Flag	Drapeau	Vlag	Bandera
1	TR140			VEJ	Transfer	Transfer	Abziehbild	Decalomanies	Transfer
1				VEJ	Byggevejledning	Building instruction	Bauanleitung	Instruction de montage	Bouwbeschrijving
1				VEJ	Tegning	Drawing	Zeichnung	Plan	Tekening

**Table of contents for WSP 10 Art. No. 408**

<b>Pes.</b>	<b>No.</b>	<b>Dimension</b>	<b>Material</b>	<b>Found in</b>	<b>E</b>	<b>I</b>	<b>P</b>	<b>PL</b>
1	P150		Plastic		Casco	Scafo	Casco	Kadhub
1	P151		Plastic		Cubierta	Ponte	Convés	Pokład
1	P152		Plastic		Camarote	Cabina	Cabine	Kabina
1	P153		Plastic		Techo	Tetto	Teto	Dach
1	A	1,5x4x600mm	Plastic	LB	Listón	Listello	Tira	Listwa
4	1	2 mm x-veneér	2170L	LAS	Hélice apoyo	Elica sostegno	Hélice soporte	Wspornik wahu
2	1a	ø6x9mm	Brass	BF-B	Hélice apoyo	Elica sostegno	Hélice soporte	Wspornik wahu
1	2	2 mm x-veneér	2170L	LAS	RC Platform	RC Platform	RC Platform	Podstawa RC
3	3	2 mm x-veneér	2170L	LAS	RC Platform	RC Platform	RC Platform	Podstawa RC
1	4	2 mm x-veneér	2170L	LAS	RC Platform	RC Platform	RC Platform	Podstawa RC
1	5	2 mm x-veneér	2170L	LAS	RC Platform	RC Platform	RC Platform	Podstawa RC
3	6	2 mm x-veneér	2170L	LAS	Apoyo	Sostegno	Supporte	Wspornik
1	7	2 mm x-veneér	2170L	LAS	Cubierta	Ponte	Convés	Pokład
4	7a	1,8x2x600mm	Obechi	LB	Listón	Listello	Tira	Listwa
2	8	1 mm x-veneér	2169L	LAS	Respiradero	Valvola	Respiradouro	Wentylacja
2	8a	1 mm x-veneér	2169L	LAS	Respiradero	Valvola	Respiradouro	Wentylacja
7	9	1 mm x-veneér	2169L	LAS	Cornamusas	Galloccia	Cunho	Knaga
14	9a	1 mm x-veneér	2169L	LAS	Cornamusas	Galloccia	Cunho	Knaga
14	9b	1 mm x-veneér	2169L	LAS	Cornamusas	Galloccia	Cunho	Knaga
14	9c	ø2x50mm	Wood	LB	Cornamusas	Galloccia	Cunho	Knaga
1	10	2 mm x-veneér	2170L	LAS	Cabrestante	Argano	Cabrestante	Kabestan
2	10a	1 mm x-veneér	2169L	LAS	Cabrestante	Argano	Cabrestante	Kabestan
2	11	1 mm x-veneér	2169L	LAS	Cabrestante	Argano	Cabrestante	Kabestan
2	12	1 mm x-veneér	2169L	LAS	Cabrestante	Argano	Cabrestante	Kabestan
1	13	1 mm x-veneér	2169L	LAS	Cabrestante	Argano	Cabrestante	Kabestan
4	14	1 mm x-veneér	2169L	LAS	Boya	Boa	Bóia	Boja
4	15	2 mm x-veneér	2170L	LAS	Boya	Boa	Bóia	Boja
1	16	2 mm x-veneér	2170L	LAS	Apoyo	Sostegno	Supporte	Wspornik
2	17	1 mm x-veneér	2169L	LAS	Ventana	Finestra	Janela	Okno
2	18	1 mm x-veneér	2169L	LAS	Ventana	Finestra	Janela	Okno
1	18a	1 mm x-veneér	2169L	LAS	Ventana	Finestra	Janela	Okno
1	19		Foil	LAS	Ventana	Finestra	Janela	Okno
10	20-24	1 mm x-veneér	2169L	LAS	Ventana	Finestra	Janela	Okno
4	22a, 25a	2 mm x-veneér	2170L	LAS	Capstana	Verricello manuale	Guincho manual	Klamka
18	25 - 32	1 mm x-veneér	2169L	LAS	Chimenea	Ciminiera	Chaminé	Komin
16	33a - 33h	1 mm x-veneér	2169L	LAS	Chimenea	Ciminiera	Chaminé	Komin
2	34	1 mm x-veneér	2169L	LAS	Chimenea	Ciminiera	Chaminé	Komin
2	35	1 mm x-veneér	2169L	LAS	Apoyo	Sostegno	Supporte	Wspornik
2	35	2 mm x-veneér	2170L	LAS	Apoyo	Sostegno	Supporte	Wspornik
8	36	1 mm x-veneér	2169L	LAS	Ventana	Finestra	Janela	Okno
6	37-37a	1 mm x-veneér	2169L	LAS	Escalera	Scaletta	Escada	Schody
10	38-39	1 mm x-veneér	2169L	LAS	Marco	Telaio	Quadro	Rama
1	40	2 mm x-veneér	2170L	LAS	Marco	Telaio	Quadro	Rama
1	41	2 mm x-veneér	2170L	LAS	Base	Base	Base	Podstawa

Pes.	No.	Dimension	Material	Found in	E	I	P	PL
6	42-42b	1 mm x-veneér	2169L	LAS	Lámpara - Base	Lampade - Base	Lámpada - Base	Lampa – podstawa
6	43-44	1 mm x-veneér	2169L	LAS	Radar	Radar	Radar	Radar
2	45	2 mm x-veneér	2170L	LAS	Radar	Radar	Radar	Radar
2	46	2 mm x-veneér	2170L	LAS	Palo	Albero	Mastro	Maszt
1	47	1 mm x-veneér	2169L	LAS	Apoyo	Sostegno	Suporte	Wspornik
8	48	1 mm x-veneér	2169L	LAS	Lámpara	Lampade	Lámpada	Lampa
1	49	1 mm x-veneér	2169L	LAS	Apoyo	Sostegno	Suporte	Wspornik
1	50	1 mm x-veneér	2169L	LAS	Capstana	Verricello manuale	Guincho manual	Klamka
2	51	1 mm x-veneér	2169L	LAS	Apoyo	Sostegno	Suporte	Wspornik
7	52-55	1 mm x-veneér	2169L	LAS	Ancla	Ancora	Âncora	Kotwica
2	56-57	3 mm x-veneér	2271L	LAS	Base	Base	Base	Podstawa
8	58-60	2 mm x-veneér	2170L	LAS	RC Apoyo	RC Sostegno	RC Suporte	Wspornik RC
4	61-63	2 mm x-veneér	2170L	LAS	RC Apoyo	RC Sostegno	RC Suporte	Wspornik RC
4	64				Clavijas	Chiodini	Pinos	Pin
1	65	ø6x9mm	Brass		Base	Base	Base	Podstawa
6	F39	ø1,0x250mm	Brass	MS	Hilo de latón	Filo in ottone	Fio de latão	Drut
4	F41	12mm	Plastic	BF-A	Cornamusas	Galloccia	Cunho	Knaga
2	F29	ø6	Rubber	TS	Cinta elástica	Nastro di gomma	Cinta de borracha	Guma
1	F53	ø6mm	Brass	BF-B	Rodillo	Pulegge	Polia	Rolka
1	F73	3m	Thread	TS	Soga	Corda	Corda	Lina
2	F82	ø4x170mm	Brass	MS, BF-B	Hélice	Supporti per corrimano	Pontalete da amurada	Wał
1	F107	ø6x6mm	Brass	BF-B	Cabrestante	Argano	Cabrestante	Kabestan
4	F121	ø6x7,5mm	Brass	BF-B	Linternas de popa	Lanterna di poppa	Luz da popa	Lampa
2	F141	20mm	Brass	BF-B	Reflector	Proiettore	Holofote	Lampa
38	F285	ø2x6mm	Brass	BF-B	Perno de cáncamo	Bullone ad occhio	Ferrolho	Uchwyt
1	F327	ø1,5x100mm	Metal	BF-B	Cadena	Catena	Corrente	Łańcuch
2	F330	ø1x10mm	Brass	BF-B	Clavo	Chiodo	Prego	Gwóźdź
2	F331	80mm	Brass	BF-B	Timón	Timone	Leme	Ster
2	F340	37x37mm	Plastic	BF-A	Cinturones salvavidas	Scialuppe da salvataggio	Bote salv-vida	Koło ratunkowe
4	F374	ø4mm	Brass	BF-B	Rodillo	Pulegge	Polia	Rolka
1	F376	ø8mm	Brass	BF-B	Rodillo	Pulegge	Polia	Rolka
1	F379	ø5x1,5mm	Brass	BF-B	Disco	Disco	Disco	Dysk
6	F409	ø1,5x600mm	Brass	MS	Hilo de latón	Filo in ottone	Fio de latão	Drut
1	F410	ø2,0x250mm	Brass	MS	Hilo de latón	Filo in ottone	Fio de latão	Drut
2	F623	ø4,8mm	Brass	BF-B	Portilla	Oblò	Escotilha	Ramka
2	F637	ø8x12mm	Brass	BF-B	Megaphone	Megafono	Megafone	Megafon
1	F643	ø10x9,5mm	Brass	BF-B	Campanilla	Campana	Sino	Dzwon
4	F655	ø28mm	Rubber	BF	Como de cojin	Parabordo	Defensa	Zderzak
20	F895		Brass	BF-B	Soporte de pasamanos	Supporti per corrimano	Poste de trilho	Poręcz
2	F898	ø35mm	Plastic	BF-A	Hélice	Elica	Hélice	Śruba napędowa
1	FL123			VEJ	Bandiera	Bandeira	Flagg	Flaga
1	FL2			VEJ	Bandiera	Bandeira	Flagg	Flaga
1	TR140			VEJ	Calcas	Decalcomania	Decalque	Kalkomania
1				VEJ	Instrucciones de montaje	Istruzioni di montaggio	Instruções de montagem	Instrukcja budowy
1				VEJ	El dibujo	Disegno	Desenho	Rysunek



## **Billing Boats**

[www.billingboats.com](http://www.billingboats.com)  
[service@billingboats.dk](mailto:service@billingboats.dk)